



ANTIPAMINERALS

**A PREMIER MINERAL
EXPLORATION AND
DEVELOPMENT COMPANY**
PROVINCE-SCALE, WORLD-CLASS
GOLD AND COPPER ASSETS IN
WESTERN AUSTRALIA

Diggers & Dealers

ASX: AZY | August 2024



DISCLAIMER

Refer to Antipa Minerals ASX release 31 August 2022, for full Minyari Dome Project Scoping Study details. Antipa Minerals confirms that it is not aware of any new information or data that materially affects the information included in that release. All material assumptions and technical parameters underpinning that release continue to apply and have not materially changed.

Nature of this document: The purpose of this document is to provide general information about Antipa Minerals Limited (the 'Company'). Unless otherwise stated herein, the information in this document is based on the Company's own information and estimates. In viewing this document you agree to be bound by the following terms and conditions.

Not an offer: This document is for information purposes only and does not constitute or form any part of any offer or invitation to sell or issue, or any solicitation of any offer to purchase or subscribe for, any securities in the Company in any jurisdiction, including the United States. This document and its contents must not be distributed, transmitted or viewed by any person in any jurisdiction where the distribution, transmission or viewing of this document would be unlawful under the securities or other laws of that or any other jurisdiction. In particular, this document is not for release to US newswire services or distribution in the United States. This document is not considered a recommendation by the Company or any of its affiliates, directors or officers that any recipient invest in the Company nor does it constitute investment, accounting, financial, legal or tax advice.

Not financial product advice: This document does not take into account the individual investment objectives, financial situation and particular needs of each of the Company's Shareholders. You may wish to seek independent financial and taxation advice before making any decision in respect of this document. Neither the Company nor any of its related bodies corporate is licensed to provide financial product advice in respect of the Company's securities or any other financial products.

Forward looking statements: Certain statements contained in this document, including information as to the future financial or operating performance of the Company and its projects, are forward looking statements. Such forward looking statements: (a) are necessarily based upon a number of estimates and assumptions that, while considered reasonable by the Company, are inherently subject to significant technical, business, economic, competitive, political and social uncertainties and contingencies; (b) involve known and unknown risks and uncertainties that could cause actual events or results to differ materially from estimated or anticipated events or results reflected in such forward looking statements; and (c) may include, among other things, statements regarding estimates and assumptions in respect of prices, costs, results and capital expenditure, and are or may be based on assumptions and estimates related to future technical, economic, market, political, social and other conditions.

The Company disclaims any intent or obligation to publicly update any forward looking statements, whether as a result of new information, future events or results or otherwise. The words "believe", "expect", "anticipate", "indicate", "contemplate", "target", "plan", "intends", "continue", "budget", "estimate", "may", "will", "schedule" and similar expressions identify forward looking statements. All forward looking statements contained in this document are qualified by the foregoing cautionary statements. Recipients are cautioned that forward looking statements are not guarantees of future performance and accordingly recipients are cautioned not to put undue reliance on forward looking statements due to the inherent uncertainty therein.

Disclaimer: No representation or warranty, express or implied, is made by the Company that the material contained in this document will be achieved or prove to be correct. Except for statutory liability which cannot be excluded, each of the Company, its directors, officers, employees, advisers and agents expressly disclaims any responsibility for the accuracy, fairness, sufficiency or completeness of the material contained in this document, or any opinions or beliefs contained in this document, and excludes all liability whatsoever (including in negligence) for any loss or damage which may be suffered by any person as a consequence of any information in this document or any error or omission there from. The Company is under no obligation to update or keep current the information contained in this document or to correct any inaccuracy or omission which may become apparent, or to furnish any person with any further information, unless required to do so by law. Any opinions expressed in the document are subject to change without notice. Recipients of this document should make their own, independent investigation and assessment of the Company, its business, assets and liabilities, prospects and profits and losses, as well as the matters covered in this document. Independent expert advice should be sought before any decision based on an assessment of the Company is made.

Unverified information: This document may contain information (including information derived from publicly available sources) that has not been independently verified by the Company.

Cautionary note regarding reserves and resources: You should be aware that as an Australian company with securities listed on the ASX, the Company is required to report reserves and resources in accordance with the Australasian Code for Reporting of Exploration Results, Mineral Resources and Ore Reserves (JORC Code, 2012 Edition). You should note that while the Company's reserve and resource estimates comply with the JORC Code, they may not comply with the relevant guidelines in other countries and, in particular, do not comply with Industry Guide 7, which governs disclosures of mineral reserves in registration statements filed with the US Securities and Exchange Commission. Information contained in this document describing the Company's mineral deposits may not be comparable to similar information made public by companies subject to the reporting and disclosure requirements of US securities laws. In particular, Industry Guide 7 does not recognise classifications other than proven and probable reserves and, as a result, the SEC generally does not permit mining companies to disclose their mineral resources in SEC filings. You should not assume that quantities reported as "resources" will be converted to reserves under the JORC Code or any other reporting regime or that the Company will be able to legally and economically extract them.

Competent Persons Statement - Exploration Results: Please refer to the detailed statement at the end of this document.

Competent Persons Statement - Mineral Resource Estimations: for the Minyari Dome Project Deposits, Calibre Deposit, Magnum Deposit, Chicken Ranch Deposit and Tim's Dome deposit: Please refer to detailed statement at end of this document.

Australian Dollars: All figures in Australian Dollars unless stated otherwise.

Release Authorised by: Roger Mason - Managing Director.



ANTIPAMINERALS

ACKNOWLEDGEMENT OF COUNTRY

Antipa Minerals acknowledges the Traditional Custodians of country throughout Australia and their connections to land, sea and community.

We pay our respect to their Elders past and present, extending that respect to all Aboriginal and Torres Strait Islander peoples today.



CORPORATE SNAPSHOT

CAPITAL STRUCTURE | ASX : AZY

Share price ¹	A\$ 0.012
Shares on issue ¹	4,710 M
Market capitalisation ¹	A\$ 56.5 M
Cash ²	A\$ 7.7 M
Debt	Nil
EV	A\$ 48.8 M
Options ³	562 M

1. At 1 August 2024.

2. Cash at 30 June 2024, Antipa cash only.

3. At 1 August 2024, 562 million unlisted options, with a weighted average exercise price of A\$0.039.

4. Shareholdings may be held directly or through nominees.

5. Newmont has exercised its right to maintain an 8.6% shareholding in Antipa on the same terms as the placement completed on 28 June 2024, subject to receipt of shareholder approval at Antipa's General Meeting to be held on 13 August 2024.

SHARE REGISTER^{4&5}

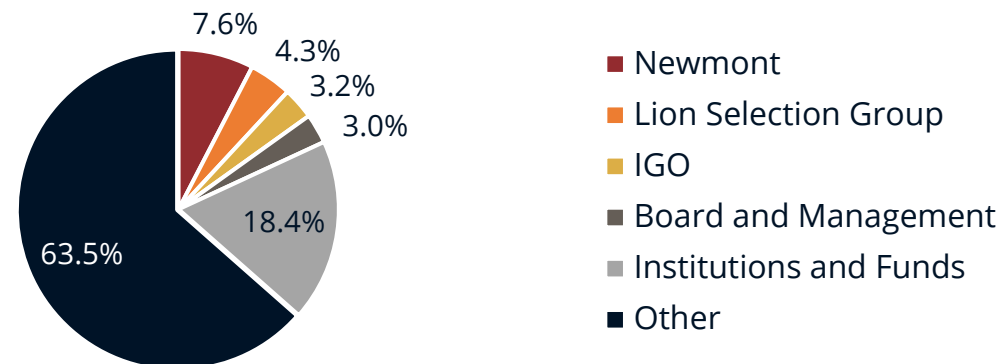

RESEARCH COVERAGE

EUROZ HARTLEYS
GROUP

Shaw and Partners
Financial Services

Cavendish

BOARD AND MANAGEMENT



Stephen Power

Non-Executive
Chairperson

- **Corporate Lawyer**
- More than 35 years legal, commercial and corporate management experience
- Former advisor to LionOre Mining International



Roger Mason

Managing
Director

- **Geologist**
- 37 years exploration, project development, production and project acquisition experience
- Former General Manager Geology for LionOre Australia and Norilsk Nickel Australia
- Former consultant to Integra Mining Ltd



Mark Rodda

Executive Director –
Commercial and Legal

- **Lawyer and Corporate Consultant**
- 30 years legal, commercial and corporate management experience
- Director of Lepidico
- Former Chairman of Coalspur Mines, and former General Counsel of LionOre Mining international



Peter Buck

Non-Executive
Director

- **Geologist**
- More than 40 years international exploration, acquisition and production experience
- Former Director of IGO, PMI Gold, Gallery Gold, LionOre Australia and Breakaway Resources



Gary Johnson

Non-Executive
Director

- **Metallurgist**
- More than 40 years plant design, project development and operations experience
- Chairman of Lepidico, and Director of Strategic Metallurgy
- Former Director of LionOre's Tati Nickel



Luke Watson

CFO and Company
Secretary

- **Chartered Accountant**
- More than 20 years resource sector senior corporate and finance experience
- Former CFO and Company Secretary of Mantra Resources

THE ANTIPA MINERALS PORTFOLIO

High impact exploration for large-scale discovery potential



2.6 Moz

ATTRIBUTABLE GOLD MINERAL RESOURCE¹



5,100 km²

OF HIGHLY PROSPECTIVE GOLD AND COPPER GROUND

OUTSTANDING LOCATION

PROXIMAL TO THE GOLD-COPPER-SILVER TELFER MINE AND HAVIERON AND WINU DEVELOPMENT PROJECTS

SCOPING STUDY CONFIRMS STAND-ALONE PROJECT POTENTIAL

A Minyari Dome
100% Antipa

COMPLEMENTARY MAJOR GROWTH PROJECTS

B Paterson (100%) : IGO Farm-in

C Citadel (32%) : Rio Tinto JV²

D Wilki (100%) : Newmont Farm-in

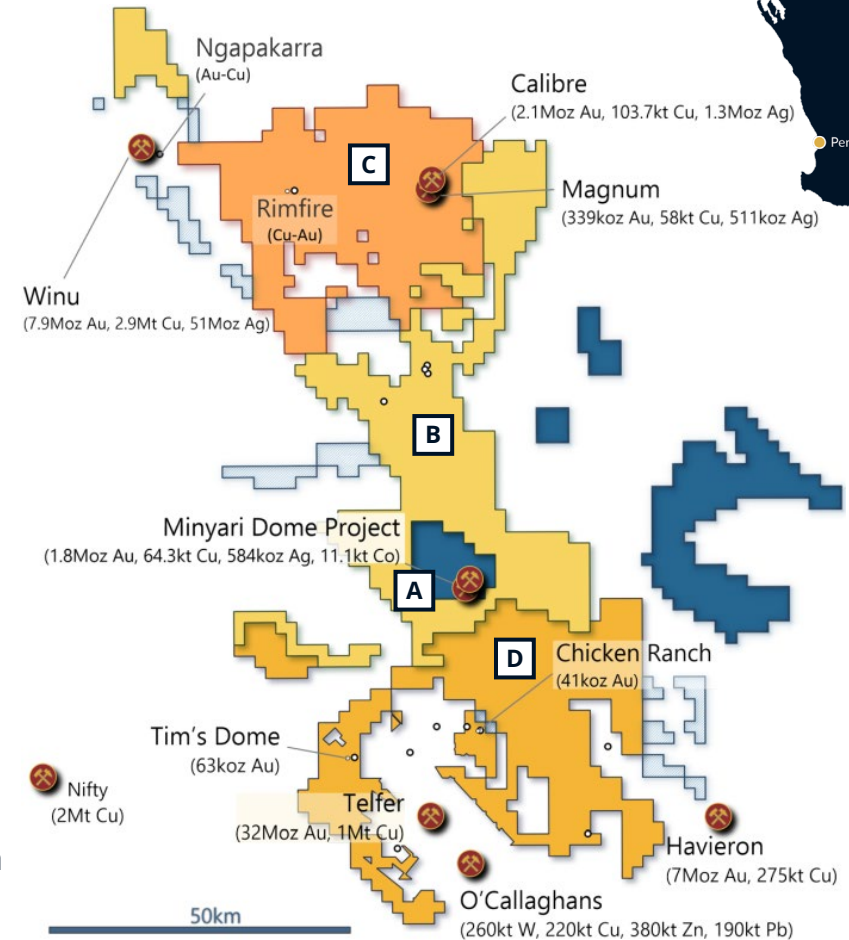

1. Refer to Antipa Minerals ASX releases dated 23 February 2015, "Calibre and Magnum Mineral Resources JORC 2012 Updates", 13 May 2019, "Chicken Ranch and Tims Dome Maiden Mineral Resources", 17 May 2021, "Calibre Gold resource Increase 62% to 2.1 Million Ounces", and 2 May 2022, "Minyari Dome Project Gold Resource Increases 250% to 1.8Moz". Antipa Minerals confirms that it is not aware of any new information or data that materially affects the information included in those releases. All material assumptions and technical parameters underpinning those releases continues to apply and has not materially changed.

2. Antipa elected to utilise the dilute-down provisions in the Citadel JV agreement to fund its share of the CY2022 and CY2023 exploration programmes, which will result in its JV interest being reduced from 35% to approximately 32%.

SHALLOW DEPTH OF YOUNGER COVER

First mover exploration and development advantage

APPROXIMATELY 50%

of Antipa tenements are under less than 20 metres of cover

APPROXIMATELY 80%

of Antipa tenements are under less than 80 metres of cover

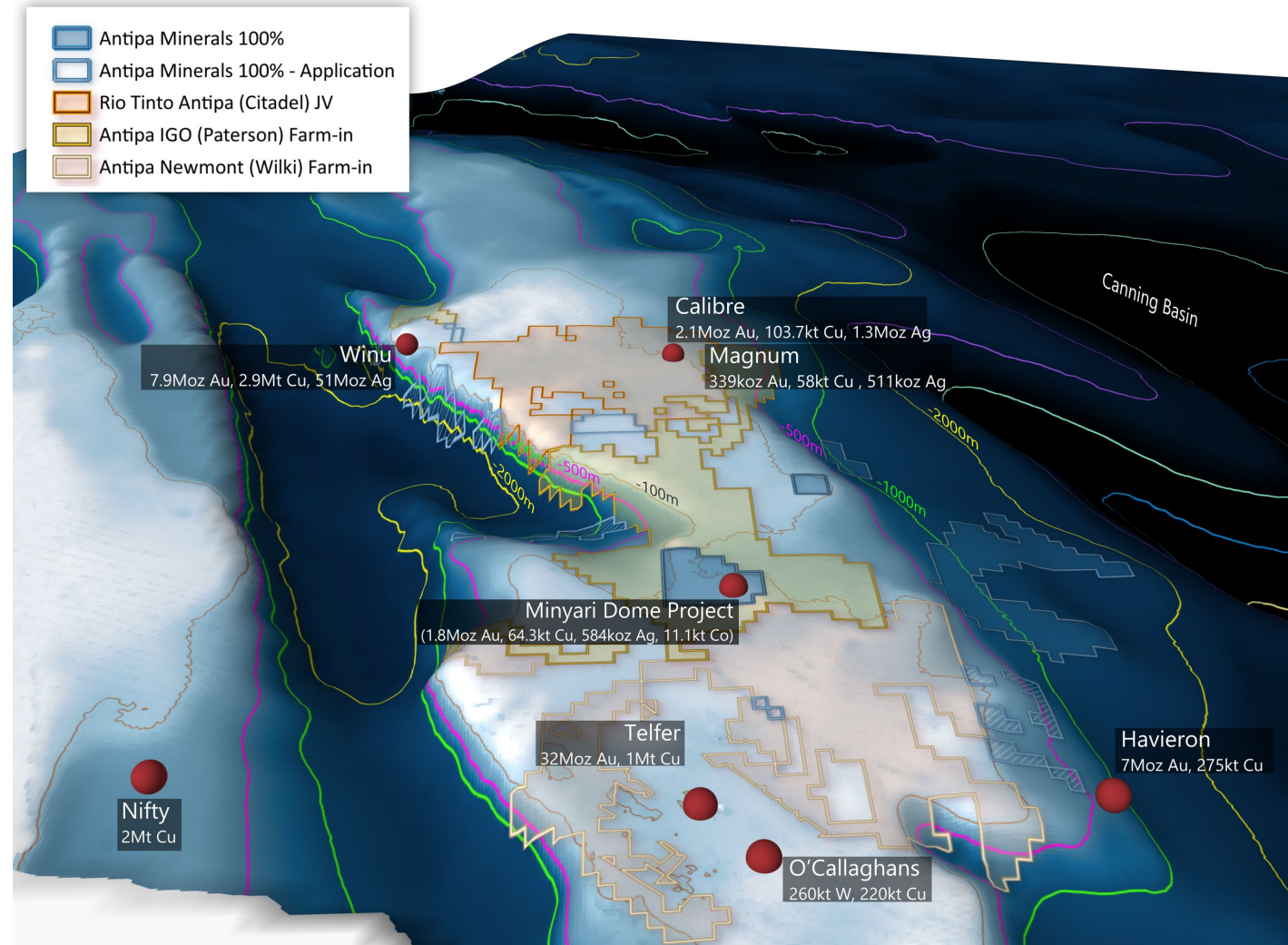



FLAGSHIP MINYARI DOME PROJECT

100% ANTIPA

SOLID FOUNDATION WITH SIZEABLE UPSIDE

1.8 Moz 2022 GOLD RESOURCE AT 1.6 g/t
PLUS Copper, Cobalt and Silver

INDICATED RESOURCE **1.0** Moz GOLD AT **1.4** g/t GOLD



Technically and commercially robust¹



Strategically significant location



Substantial potential upside drivers

2022 SCOPING STUDY OUTCOMES¹

MINE SCHEDULE

21.4 Mt at 1.6 g/t Au
Initial open pit and underground mine

MINING PHYSICALS

3 Mtpa throughput
For 7+ years initial processing life

INITIAL GOLD OUTPUT

975 koz
Average of 168 koz pa for the first 5 yrs

NPV_{7%}

A\$392M
Pre-tax at A\$2,430/oz gold

IRR

34%
Pre-tax at A\$2,430/oz gold

CAPITAL COST

A\$275M
Including A\$68M pre-production mining

1. Minyari Dome Scoping Study (August 2022) completed to ±35% level of accuracy.

A

EXISTING STAND-ALONE PROJECT POTENTIAL

Attractive Foundation with Sizeable Upside

1.1 Moz 2022 MINING INVENTORY
AT 1.6 g/t GOLD (Plus 390koz Silver)¹

POTENTIAL UPSIDE DRIVERS



Increased Mining Inventory



Increased metal price revenue drivers



Improved metallurgical performance



Third party processing opportunities

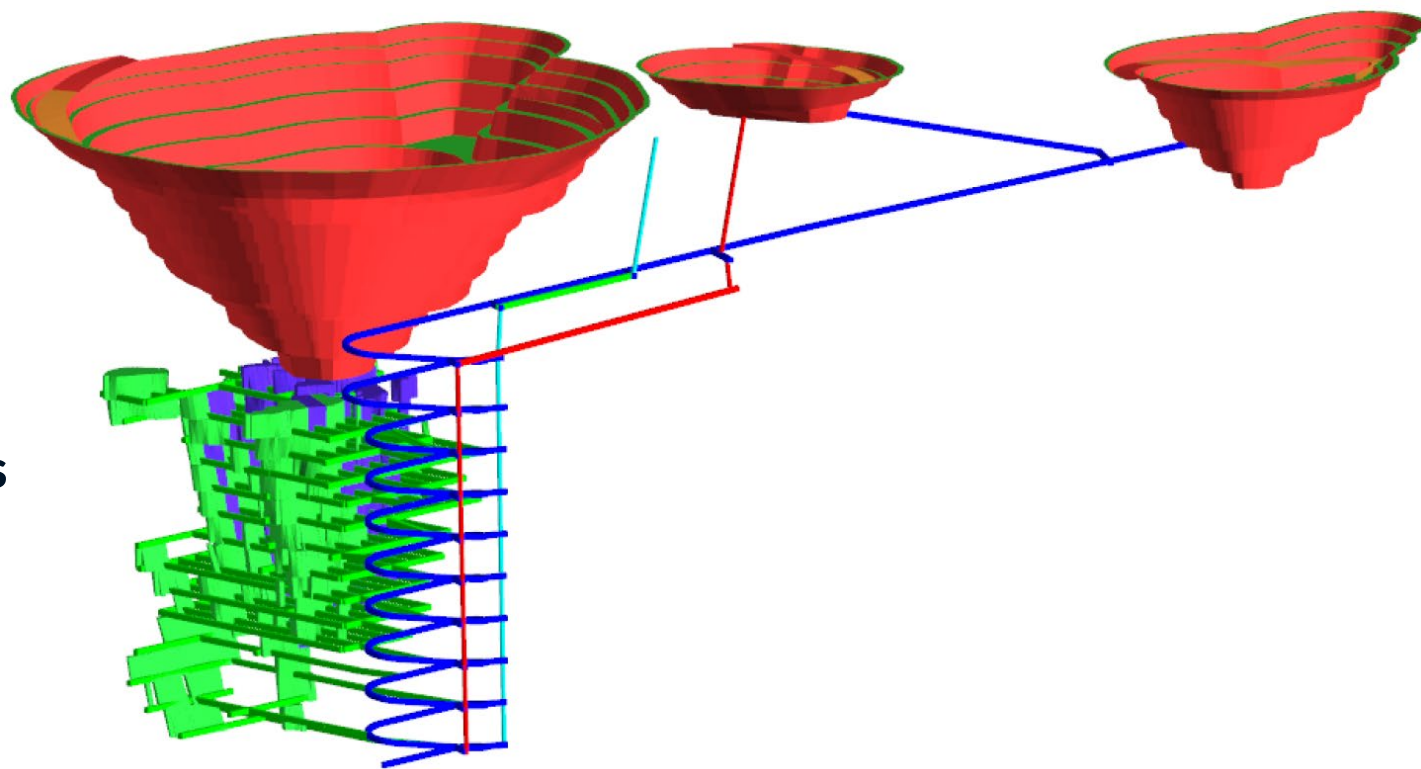

¹Minyari Dome Scoping Study (August 2022) completed to ±35% level of accuracy.

A

SUSTAINED A\$ SPOT GOLD PRICE STRENGTH

Minyari Dome Project economics and size of exploration prize to strongly benefit

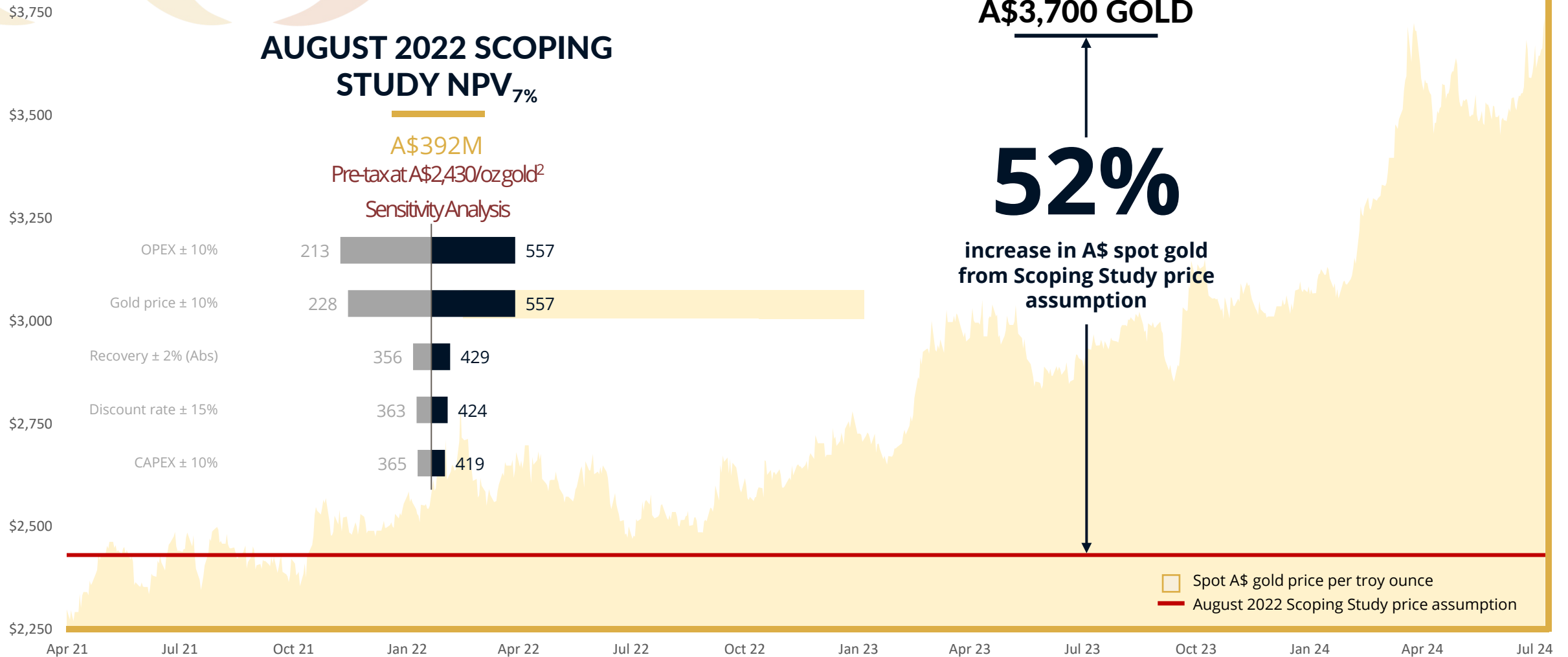

1. Source: www.gold.org. 2. Minyari Dome Scoping Study (August 2022) completed to ±35% level of accuracy.

A

PIPELINE OF HIGH-IMPACT DEVELOPMENT FOCUSSED ACTIVITIES

CY2024 exploration outline at 100% owned Minyari Dome Project¹

Targeting resource growth, discoveries and advancing the development opportunity

- Phase 1 Programme 15,242m drilling completed in June:
 - Multiple 30 to 100 gram-metre gold intersections at the GEO-01 discovery
 - Confirmed exciting GEO-01 extensional targets for thick, high-grade gold mineralisation
 - Identified multiple new zones of high-grade gold-copper mineralisation across the broader GEO-01 prospect area
 - Intersected high-grade gold mineralisation at the Minyari resource extension target and GP01 target
 - Tested two of the three Pacman greenfield targets
- Phase 2 Programme commenced:
 - Near-surface maiden gold ± copper GEO-01 Mineral Resource in August¹
 - Scoping Study update Q3 CY2024¹
 - Phase 2 drilling programme design under development
 - Recommencement of the Pre-Feasibility Study Q4 CY2024¹

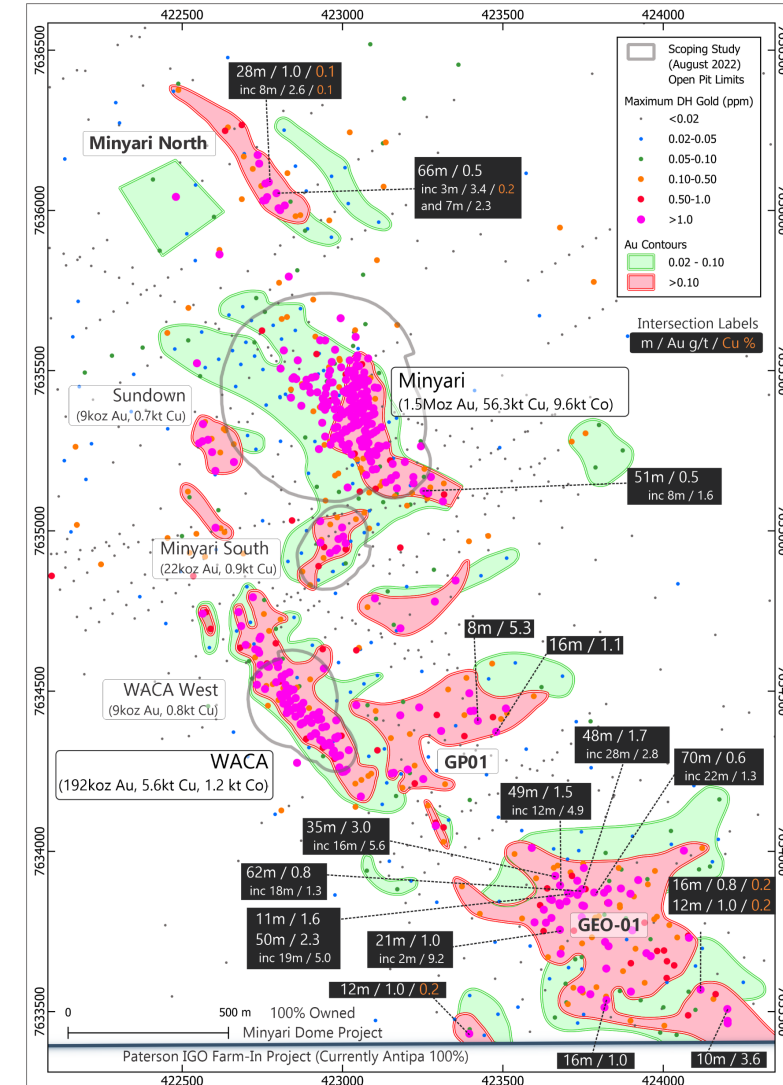

¹ Exploration programmes and development studies are subject to changes which may be made consequent upon results, field conditions and ongoing review.

A

MULTIPLE CY2024 DRILLING PROGRAMMES

Multiple gold-copper targets across Minyari Dome

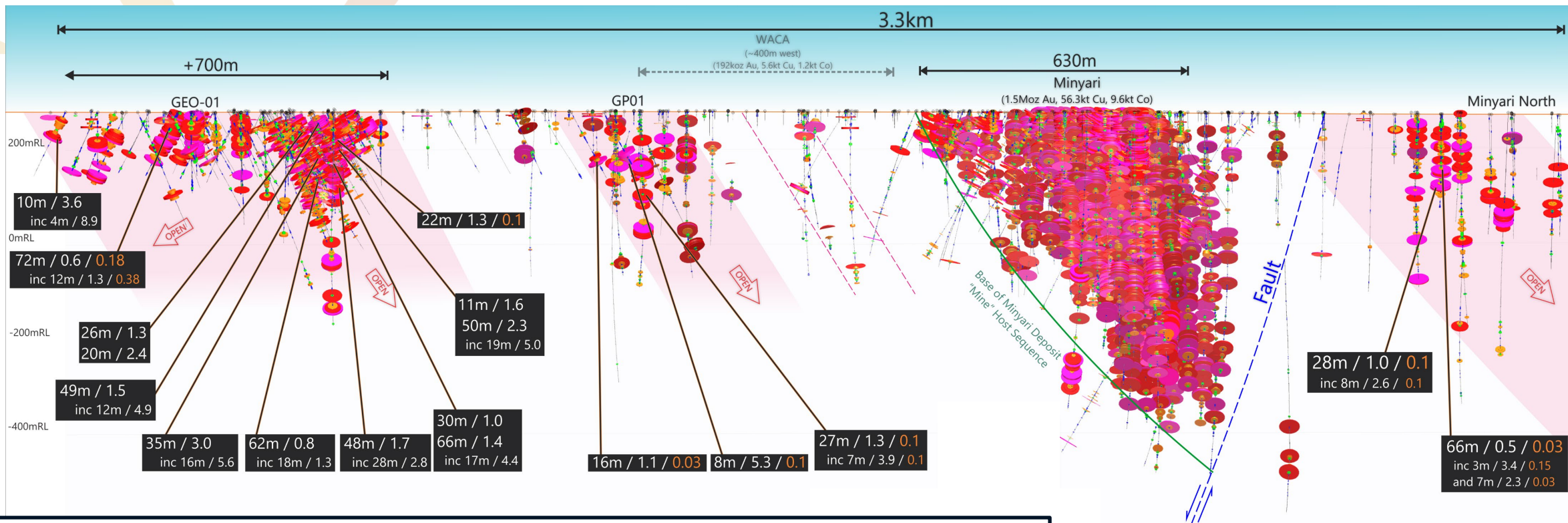

LONG SECTION

- **Minyari:** Thick breccia & vein mineralisation starts at surface and delivers 3,000oz per vertical metre
- **GEO-01:** 2023 and 2024 drilling intersected thick high-grade near surface gold ± copper mineralisation - Prospect footprint approximately 700m x 500m - Maiden resource August 2024
- **GP01:** High-grade gold mineralisation
- **Minyari North:** Gold-copper mineralisation over a 300m long zone which remains open

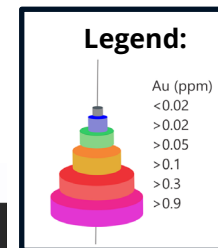

Intersection Labels
m / Au g/t / Cu %

A

GEO-01 DISCOVERY

Open pit amenable maiden gold resource opportunity

- Significant near-surface high-grade gold mineralisation intersected:
 - **35m at 3.0 g/t gold** from 20m down hole in 24MYC0610, including:
 - **16m at 5.6 g/t gold** from 33m
 - **50m at 2.3 g/t gold** from 72m down hole in 23MYC0383, including:
 - **19m at 5.0 g/t gold** from 89m
 - **20m at 2.4 g/t gold** from 114m down hole in 24MYC0442, including:
 - **11m at 3.4 g/t gold** from 122m
 - **48m at 1.7 g/t gold** from 132m down hole to EoH in 23MYC0384, including:
 - **28m at 2.8 g/t gold** from 133m
 - **66m at 1.4 g/t gold** from 118m down hole in 24MYC0441, including:
 - **17m at 4.4 g/t gold** from 157m, also including:
- Mineralisation remains open in several directions
- Under only 3 to 16 metres of sand cover
- Multiple new zones of high-grade mineralisation across prospect
- Just 1.3km from 1.5Moz Minyari gold resource
- Substantial maiden resource opportunity – MRE August

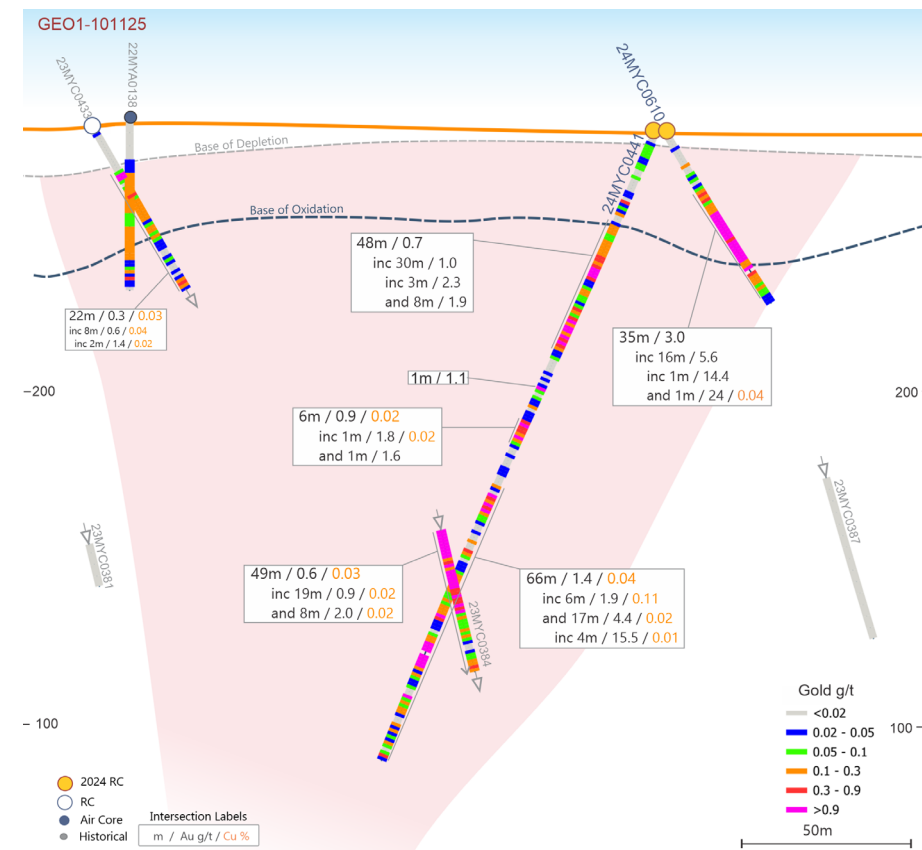

SIGNIFICANT POTENTIAL OPEN PIT AMENABLE MAIDEN RESOURCE OPPORTUNITY

1. Exploration programmes and development studies are subject to changes which may be made consequent upon results, field conditions and ongoing review.

A

GEO-01 DISCOVERY

Open pit amenable maiden gold resource opportunity

- GEO-01 deposit plan view showing drill intersections and interpreted mineralisation envelopes
- GEO-01 prospect gold ± copper mineralisation footprint increased to 700m by 500m
- Main zone of ENE trending thick high-grade gold mineralisation defines northern prospect limit:
 - Phase 1 drilling extended Main Zone's strike to 500m and across strike width to between 10 to 190m
 - Thick, high-grade gold mineralisation remains open down plunge and along a prospective contact on its northern edge which remains largely untested
- Multiple zones of mineralisation remain open, with large areas of the broader GEO-01 prospect area to be tested for mineralisation strike and depth extensions during Phase 2 drilling:
 - **10 metres at 3.6 g/t gold**
 - **12 metres at 1.3 g/t gold and 0.4% copper**

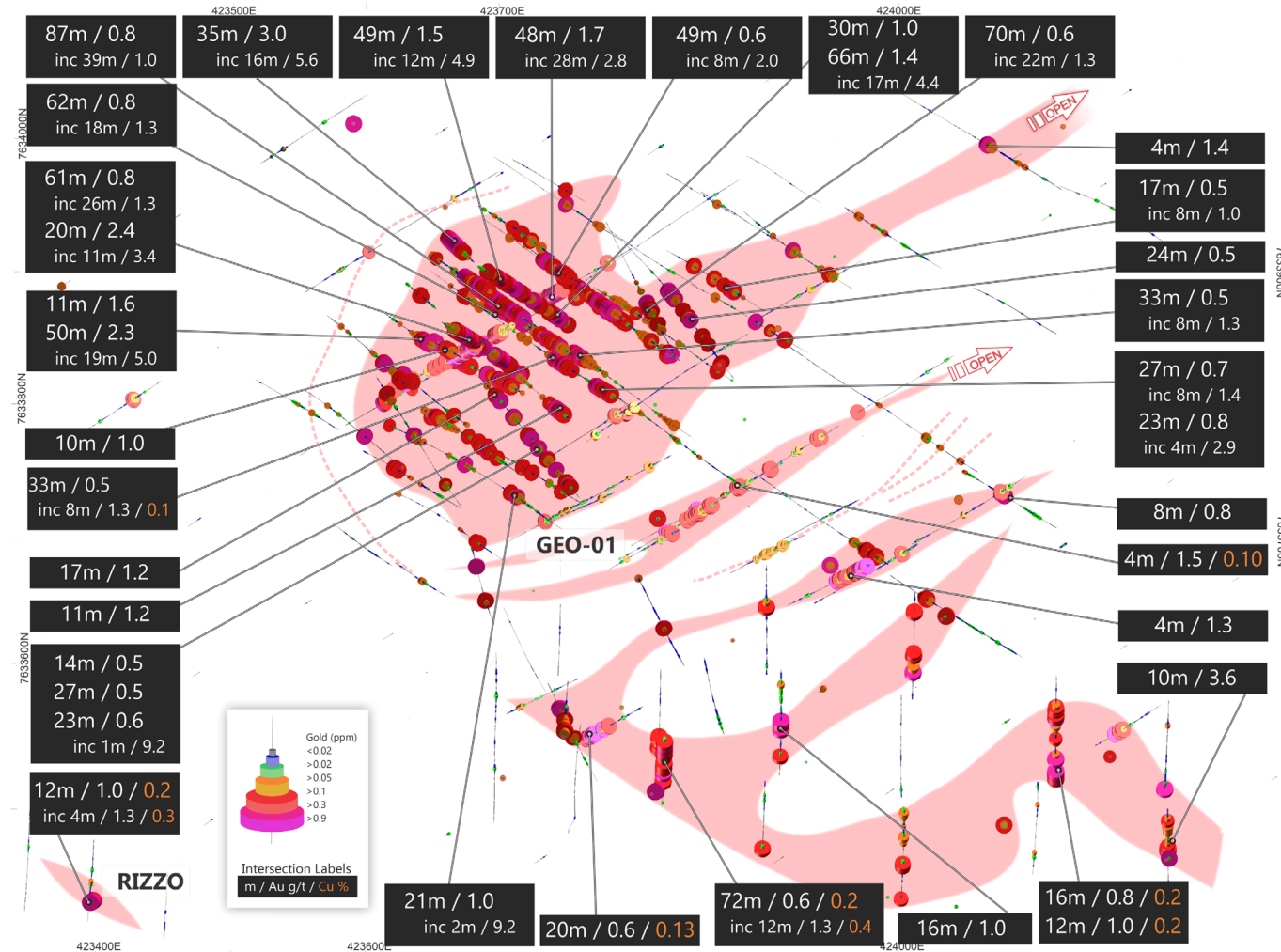

1. Exploration programmes and development studies are subject to changes which may be made consequent upon results, field conditions and ongoing review.

ANTIPA PORTFOLIO EXPLORATION OPTIONALITY

Investor leverage to future exploration success

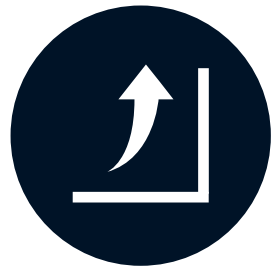

SUBSTANTIAL EXPLORATION UPSIDE POTENTIAL

Shareholders access leverage to significant discovery opportunities in the highly prospective Paterson Province with dilution minimised

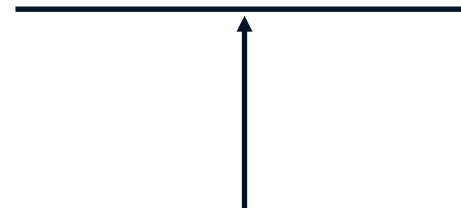

Shareholders benefit from large group exploration spend leverage



MINYARI DOME
(100% ANTIPA)
900km²



SIGNIFICANT EXPLORATION SPEND ACROSS HUGE 5,100km² PORTFOLIO

PATERSON (100% ANTIPA) 1,550km ²
WILKI (100% ANTIPA) 1,470km ²
CITADEL JV (32% ANTIPA ¹) 1,200km ²
MINYARI DOME (100% ANTIPA) 900km ²



1. Antipa elected to utilise the dilute-down provisions in the Citadel JV agreement to fund its share of the CY2022 and CY2023 exploration programmes, which will result in its JV interest being reduced from 35% to approximately 32%.

JV AND FARM-IN PORTFOLIO EXPLORATION

CY2024 exploration at our major growth projects¹



PATERSON FARM-IN (100% ANTIPA : IGO)

Exploring for sediment-hosted copper deposits with potential gold and/or cobalt credits

- FY2024 programme included 9,190m of diamond core, RC and air core drilling
- H2 FY2024 diamond core 2,607m drilling programme completed – Results pending
- FY2024 A\$4.2 million programme and FY2025 programme fully funded and operated by IGO



CITADEL JV² (32% ANTIPA : RIO TINTO)

Pursuing greenfield targets for future ore supply to Rio Tinto's planned Winu copper-gold-silver processing facility

- Project scale interpretation, data modelling and target generation
- Drill programme planning and budgeting
- Antipa operators



WILKI FARM-IN (100% ANTIPA : NEWMONT)

Targeting greenfield discoveries for future ore supply to Telfer's 22Mtpa gold-copper-silver processing facility

- Parklands greenfield gold target exploration programme currently in development
- Ongoing project scale interpretation and data modelling expected to produce additional drill targets
- FY2024 and FY2025 programme budgets fully funded and operated by Newmont

1. Exploration programmes and development studies are subject to changes which may be made consequent upon results, field conditions and ongoing review.

2. Antipa elected to utilise the dilute-down provisions in the Citadel JV agreement to fund its share of the CY2022 and CY2023 exploration programmes, which will result in its JV interest being reduced from 35% to approximately 32%.

D

NEW PARKLANDS TARGET

A very large-scale surface geochemical gold anomaly

CURRENT TARGETS

- Parklands surface geochemical gold anomaly:
 - Very large 3km long by up to 1.5km wide
- Extensive Parklands-Chicken Ranch NW-SE trend
- Broader NP40 NW-SE trend connecting Havieron, GEO-01 and Minyari

CY2024 PROGRAMME STRUCTURE¹

- Parklands large scale Heritage Survey completed
- Tim's Dome drilling
- Ongoing surface geochemical sampling programme
- Focused on greenfield discovery at Havieron, Winu and Telfer analogue targets within 10 to 50km of Newmont's Telfer gold-copper-silver mine and 22Mtpa processing facility
- Exploration programme to be fully funded and operated by Newmont

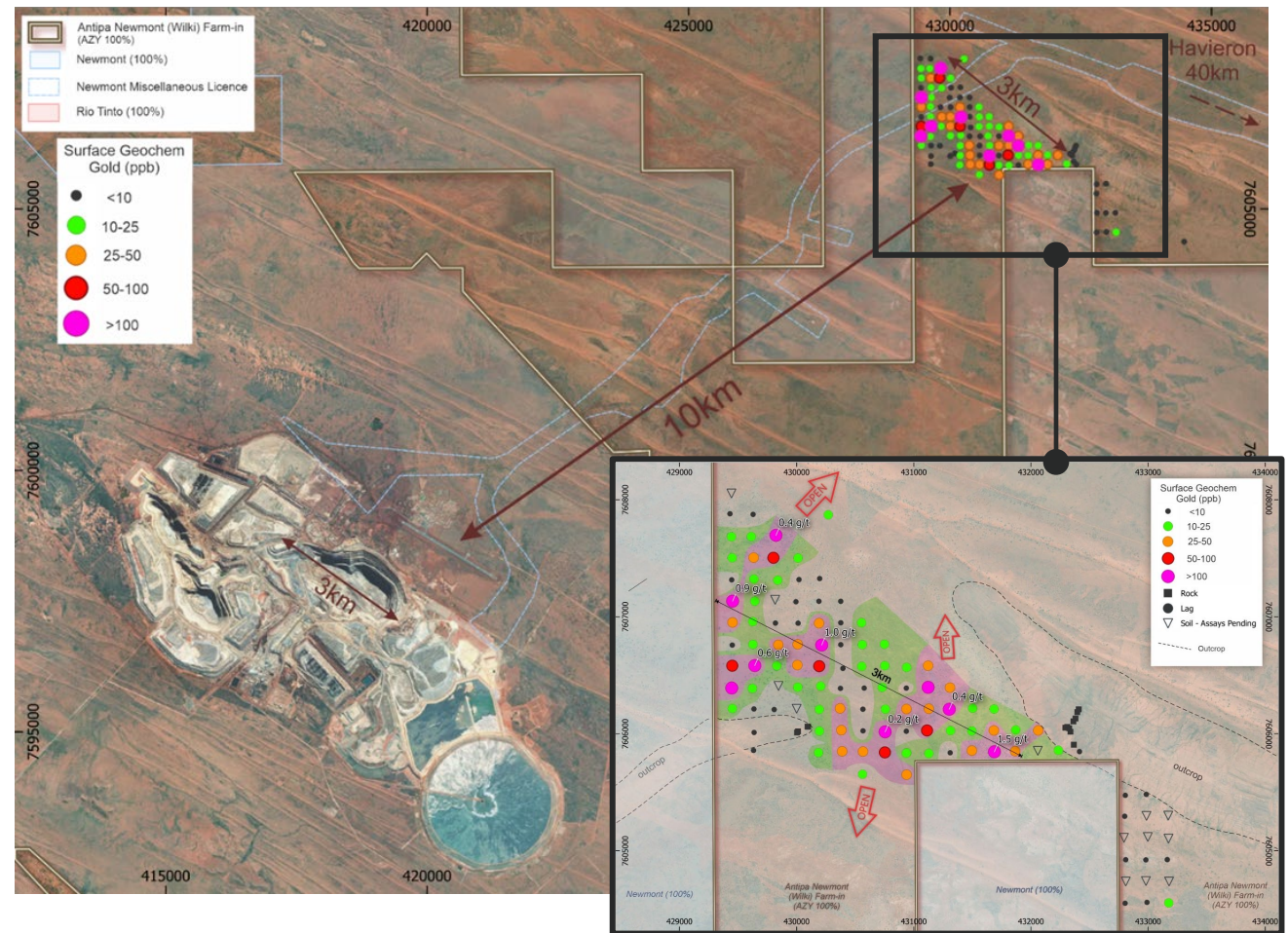

1. Exploration programmes and development studies are subject to changes which may be made consequent upon results, field conditions and ongoing review.

B

MULTIPLE TARGETS SURROUNDING MINYARI

Including exciting Havieron analogue targets

CURRENT TARGETS

- Two co-incident magnetic-gravity high Havieron analogue targets 11 to 25km from Minyari
- Multiple air core and soil targets 2 to 40km from Minyari
- Reaper-Poblano-Serrano gold-copper corridor 35km from Minyari

CY2024 PROGRAMME STRUCTURE¹

- Exploration activities:
 - Diamond core drilling at PP-GRAV02 and PP-GRAV01 seven holes for 2,607m - Results pending
 - Comprehensive large-scale hydrochemistry sampling programme - Results pending
 - Geophysical surveys including DHEM
 - Air core drill programme Q3 CY2024
- FY2024 and FY2025 programme budgets fully funded and operated by IGO

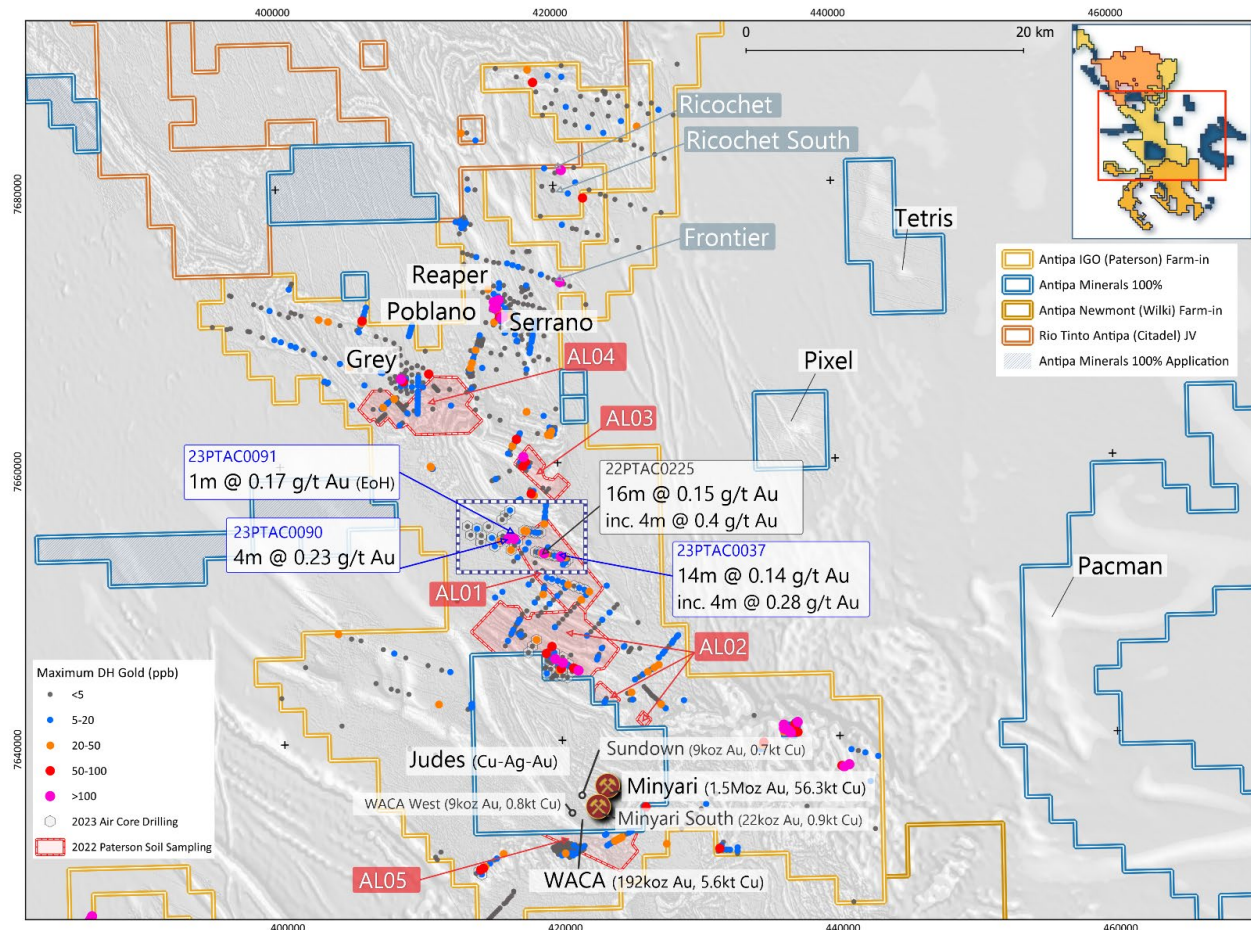

1. Exploration programmes and development studies are subject to changes which may be made consequent upon results, field conditions and ongoing review.

B

AL01 VERY LARGE-SCALE AIR CORE GOLD TARGET

5km long air core gold and pathfinder anomaly just 17km from Minyari

- AL01 located 17km north of Minyari
- 2023 air core drilling extended AL01 anomaly to a 5km long target
- Meta-sediment hosted gold and pathfinder anomaly:
 - Extensive mineral system pathfinder anomalism, including Cu, Co, Bi, Te, Mo, Pb and Zn
- Broad spaced AL01 air core drill holes:
 - 400m to 1.4km apart, with some 200m spaced
- Cover ranging from 1 to 65m
- Magnetics folded meta-sediments:
 - Extensive destruction of the magnetic response possibly due to hydrothermal alteration
- Follow up RC ± diamond drilling required

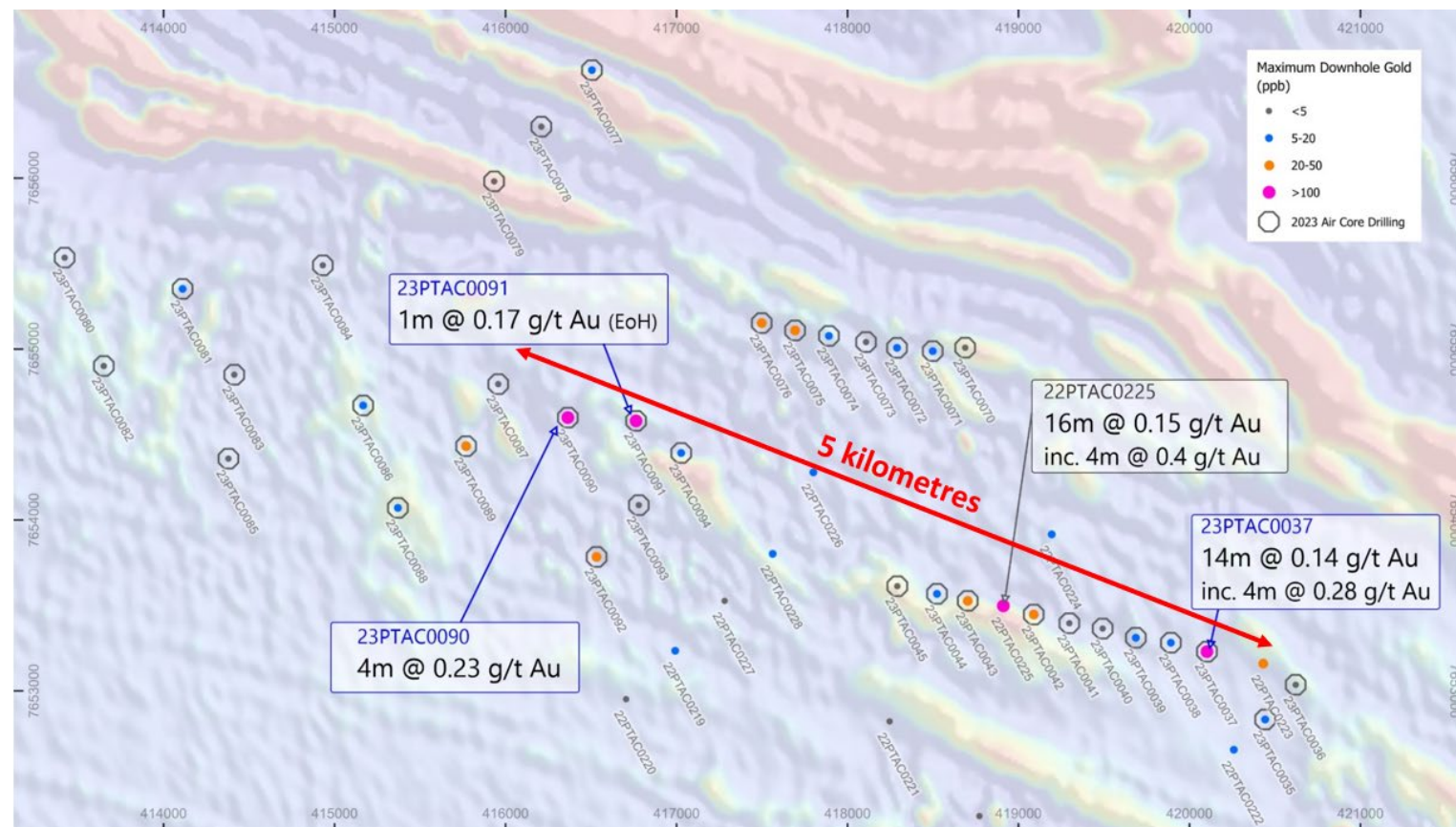

1. Exploration programmes and development studies are subject to changes which may be made consequent upon results, field conditions and ongoing review.



EXTENSIVE RIMFIRE GOLD-COPPER MINERALISATION

Multiple greenfield discovery opportunities only 20km from Winu

CURRENT TARGETS

- Rimfire intrusion's 20km aureole hosts multiple zones of gold-copper mineralisation:
 - Significant anomalous to ore grade gold and/or copper drill intersections highlight major discovery potential
 - 12.0m at 2.4 g/t gold and 0.1% copper in RFRN0002
 - 26.1m at 0.5 g/t gold and 0.2% copper in RFRN0005, including:
 - 9.6m at 1.0 g/t gold and 0.3% copper
- Crow's Nest and Coupers Reward 6 to 15km from Calibre

H2 CY2024 PROGRAMME STRUCTURE¹

- Final exploration programme design pending
- Focused on large-scale greenfield discoveries of copper ± gold deposits within 50km of Rio Tinto's planned Winu processing facility
- Currently funded by Rio Tinto and operated by Antipa^{1,2,3}

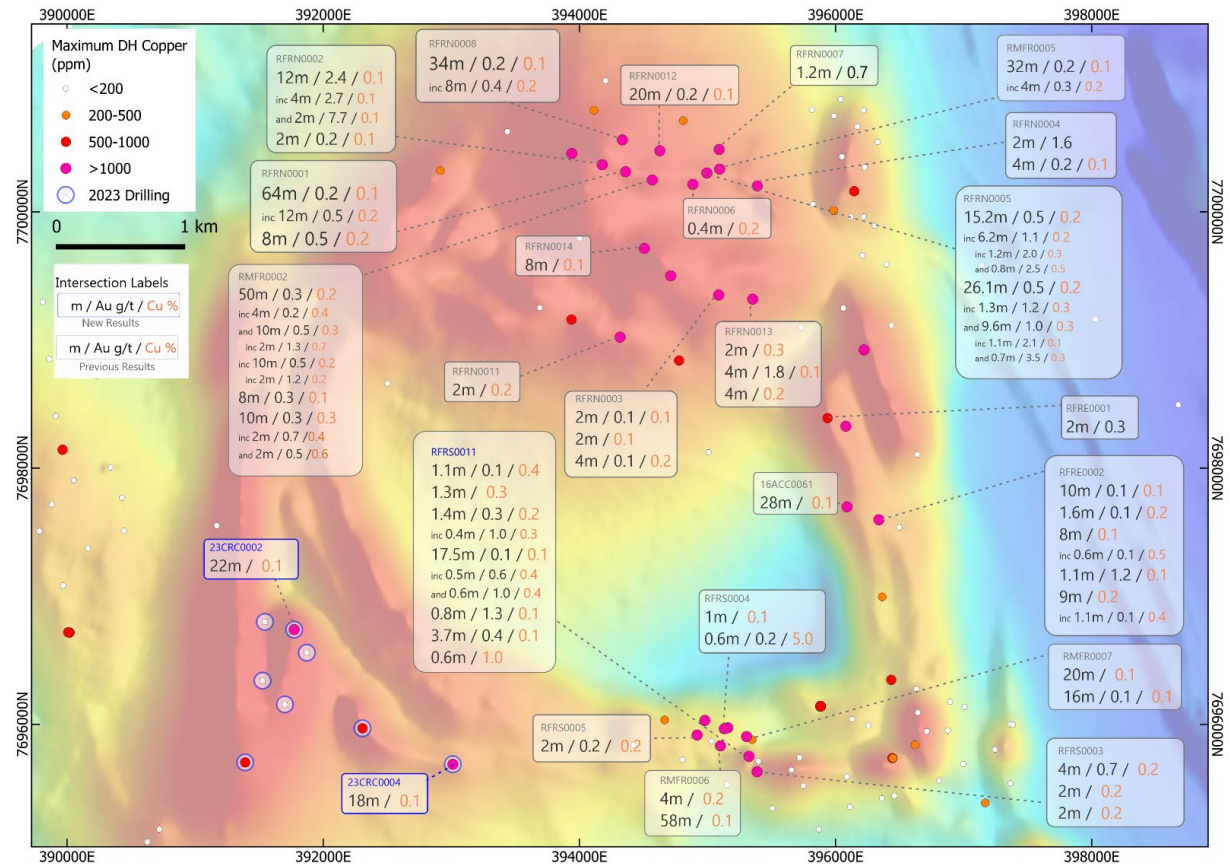

1. Exploration programmes and development studies are subject to changes which may be made consequent upon results, field conditions and ongoing review.

2. Antipa elected to utilise the dilute-down provisions in the Citadel JV agreement to fund its share of the CY2022 and CY2023 exploration programmes, which will result in its JV interest being reduced from 35% to approximately 32%.

3. Antipa may also elect to utilise the dilute-down provisions in the Citadel JV agreement to fund its share of the CY2024 exploration programme.



CITADEL JV PROJECT 2.4MOZ GOLD RESOURCE 32% ANTIPA

Geology and scale suggests substantial growth and development potential

CALIBRE DEPOSIT (SHOWN RIGHT)

- Inferred Mineral Resource 92Mt at 0.72 g/t gold, 0.11% copper and 0.46 g/t silver for 2.1Moz gold, 104kt copper and 1.3Moz silver¹
- 1.7km long, up to 480m thick and extends 500m down dip - open in most directions
- Only 80 metres of cover
- Just 45km from Winu

MAGNUM DEPOSIT

- Just 1km from Calibre
- Inferred Mineral Resource 16.1Mt at 0.66 g/t gold, 0.36% copper and 0.99 g/t silver for 339koz gold, 58kt copper and 511koz silver¹
- 2km long, up to 600m thick and extends 600m down dip - open in most directions
- Only 80 metres of cover

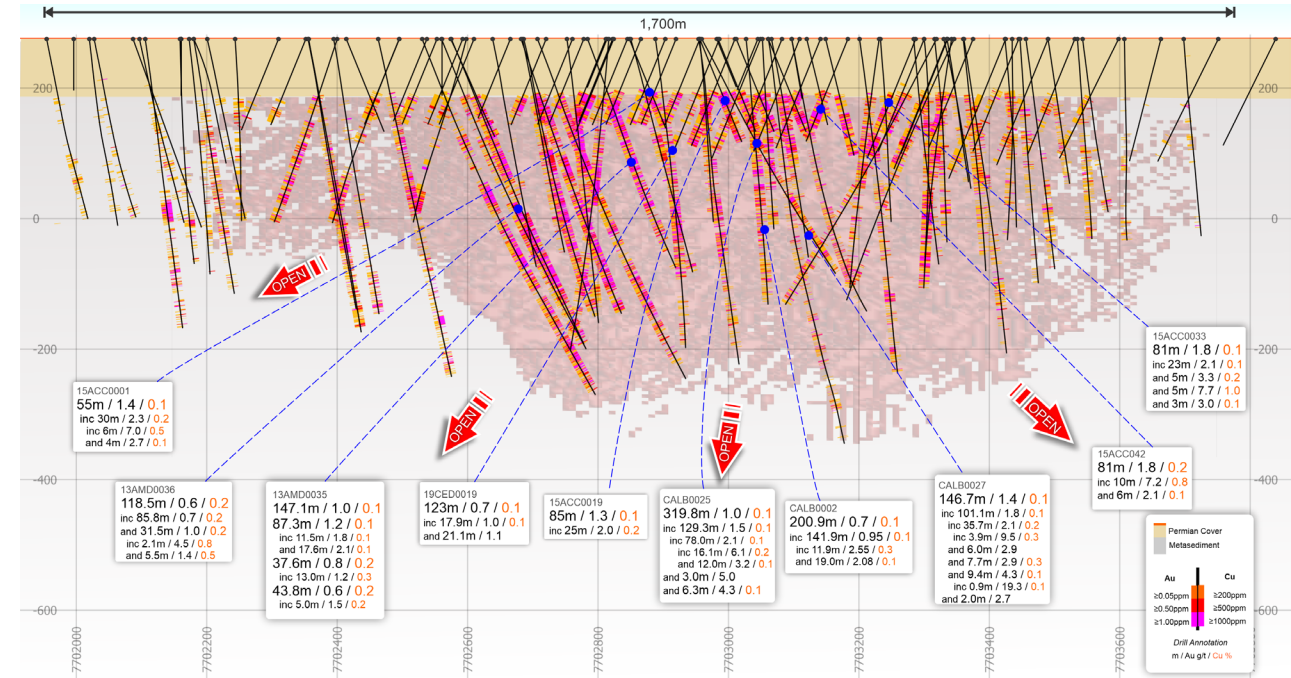

1. Refer to Antipa Minerals ASX releases dated 17 May 2021, "Calibre Gold resource Increase 62% to 2.1 Million Ounces". Antipa Minerals confirms that it is not aware of any new information or data that materially affects the information included in those releases. All material assumptions and technical parameters underpinning those releases continues to apply and has not materially changed.

2. Antipa elected to utilise the dilute-down provisions in the Citadel JV agreement to fund its share of the CY2022 and CY2023 exploration programmes, which will result in its JV interest being reduced from 35% to approximately 32%.

NEAR-TERM CATALYSTS

Drilling across multiple projects, maiden resource and upcoming studies¹



MULTIPLE UPCOMING DRILLING EVENTS

District-scale gold ± copper discovery opportunities

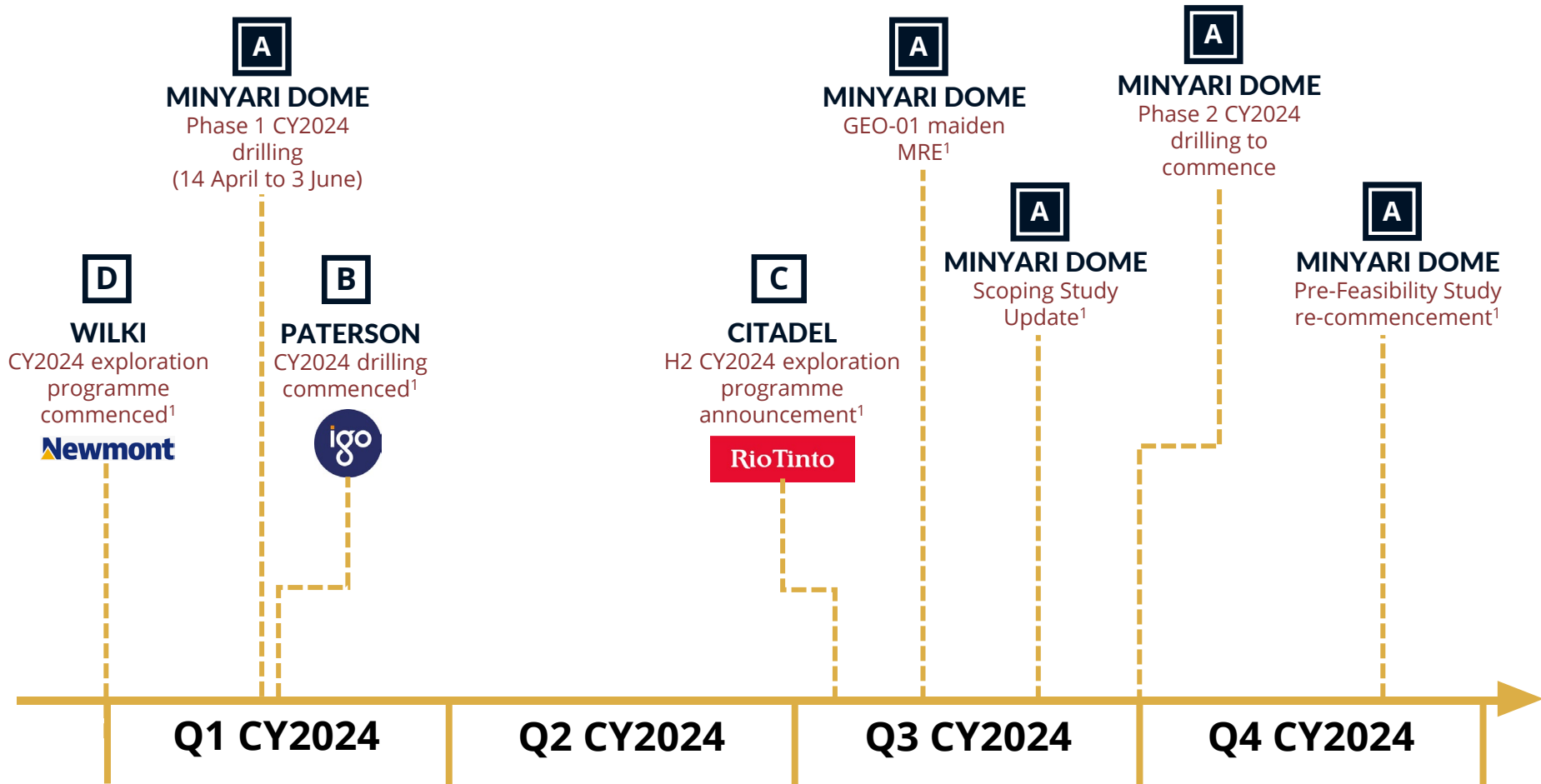

¹ Exploration programmes and development studies are subject to changes which may be made consequent upon results, field conditions and ongoing review.



ANTIPAMINERALS



LOCAL COMMUNITY PARTNERSHIPS

Engaging local people
and businesses for
wide-ranging social
benefit



REGIONAL ECONOMIC DEVELOPMENT

Exploration investment
for regional WA
long-term economic
prosperity



CULTURAL HERITAGE PROTECTION

Collaborating with
Traditional Owners to
protect cultural
landscapes and heritage



SOCIALLY INCLUSIVE WORKPLACE

Committed to
workplace diversity
and equal opportunity
employment

MEANINGFUL VALUE CREATION FOR ALL STAKEHOLDERS

EMERGING AS A SIGNIFICANT GOLD AND COPPER BUSINESS

OUTSTANDING LOCATION

PROXIMAL TO THE TELFER MINE
AND WINU AND HAVIERON
DEVELOPMENT PROJECTS

- Paterson region has been historically underexplored
- Prospective frontier for the discovery of multi-cycle, tier-one gold-copper deposits
- In the last 8 years approximately 20Moz of gold and 3Mt of copper discovered
- Western Australia is a low-risk, mining-friendly jurisdiction

RESOURCE GROWTH POTENTIAL

ONGOING EXPLORATION
WITH FUTURE EXPANSION
UPSIDE

- Existing 2.6Moz attributable group gold Mineral Resource¹
- Aggressive CY2024 drilling programme at Minyari Dome Project (100% Antipa)
- Additional, substantial exploration leverage across the JV and Farm-in portfolio through CY2024
- Current and future value pathways for shareholders

STRATEGIC PARTNERSHIPS

HIGH QUALITY PARTNERS

- Strategic JV and farm-in agreements with Rio Tinto, Newmont and IGO
- Combined historical partner contribution of +A\$56M of exploration spend
- Cumulative potential free-carry exploration spend of up to A\$115M
- Strong major discovery objectives and actions

1. Refer to Antipa Minerals ASX releases dated 23 February 2015, "Calibre and Magnum Mineral Resources JORC 2012 Updates", 17 May 2021, "Calibre Gold resource Increase 62% to 2.1 Million Ounces", and 2 May 2022, "Minyari Dome Project Gold Resource Increases 250% to 1.8Moz". Antipa Minerals confirms that it is not aware of any new information or data that materially affects the information included in those releases. All material assumptions and technical parameters underpinning those releases continues to apply and has not materially changed.



ANTIPAMINERALS



JV AND FARM-IN PROJECT OVERVIEW

B

PATERSON FARM-IN PROJECT (100% ANTIPA)

LARGE-SCALE 1,550km² LAND HOLDING

ATTRACTIVE FARM-IN WITH IGO¹

LOCATED WITHIN 22km OF THE TELFER GOLD-COPPER-SILVER MINE AND 22Mtpa PROCESSING FACILITY

AGREEMENT TO SPEND A\$30M FOR 70% JV INTEREST BY 8 JANUARY 2027 WITH A\$9M SPENT BY IGO TO DATE. ANTIPA IS FREE CARRIED TO COMPLETION OF A FEASIBILITY STUDY ON ANY PROPOSED MINING OPERATION WITHIN THE PROJECT AREA

GOLD-COPPER-SILVER MINERALISATION INTERSECTED

NIFTY, WINU, TELFER AND HAVIERON ANALOGUE TARGETS
MULTIPLE EXCITING GEOPHYSICAL, AIR CORE AND SOIL TARGETS

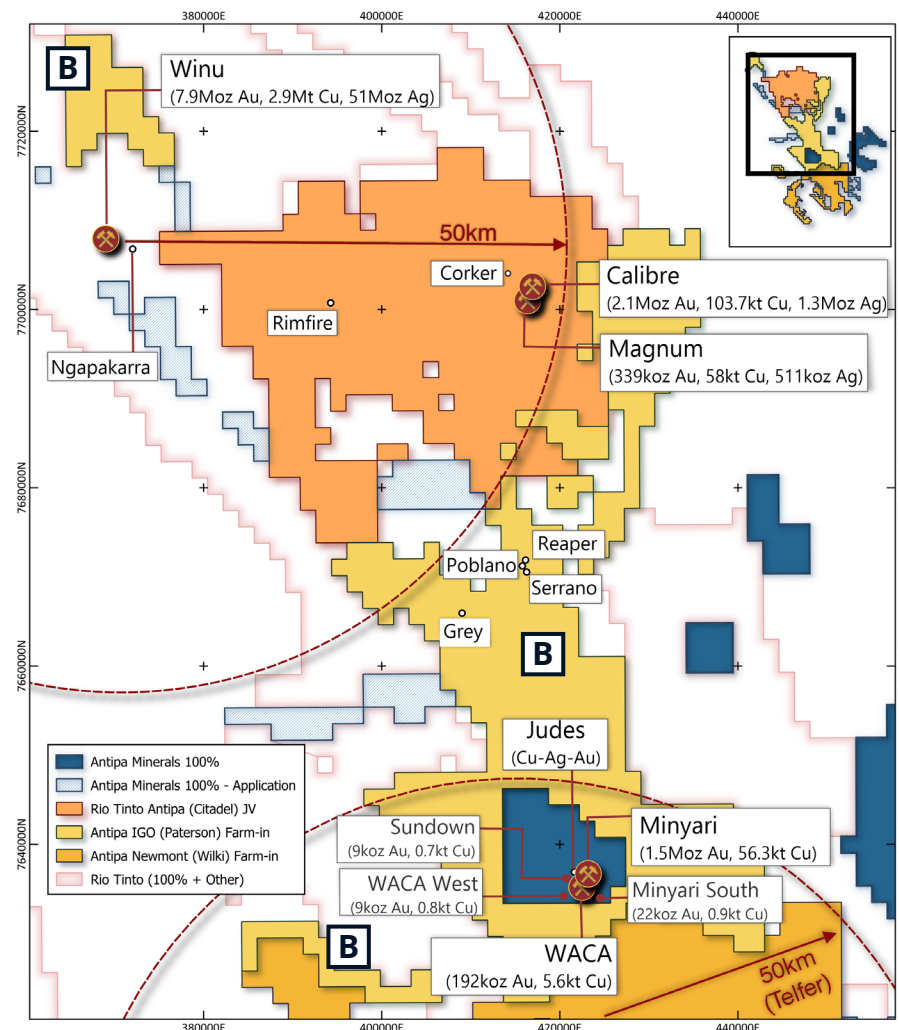

1. IGO may earn a 70% interest in the Paterson Project by funding a total of \$30M consisting of A\$4M of exploration by January 2023 (Stage 1 condition satisfied December 2021) and a further A\$26M by January 2027 (Stage 2). Upon joint venture formation, IGO shall free-carry Antipa to completion of a Feasibility Study.

C CITADEL JV PROJECT (32% ANTIPA)

1.1 **GOLD EQUIVALENT** Moz **ATTRIBUTABLE RESOURCE¹**

STRATEGIC JOINT VENTURE WITH RIO TINTO²
1,200km² LAND HOLDING ALL LOCATED WITHIN
50km OF RIO TINTO'S WINU COPPER-GOLD-SILVER
DEVELOPMENT PROJECT

108 MT MINERAL RESOURCE

Au 2.4 Moz (0.8 Moz attributable) at 0.72 g/t

Cu 162 kt (52 kt attributable) at 0.15%

Ag 1.8 Moz (0.6 Moz attributable) at 0.54 g/t

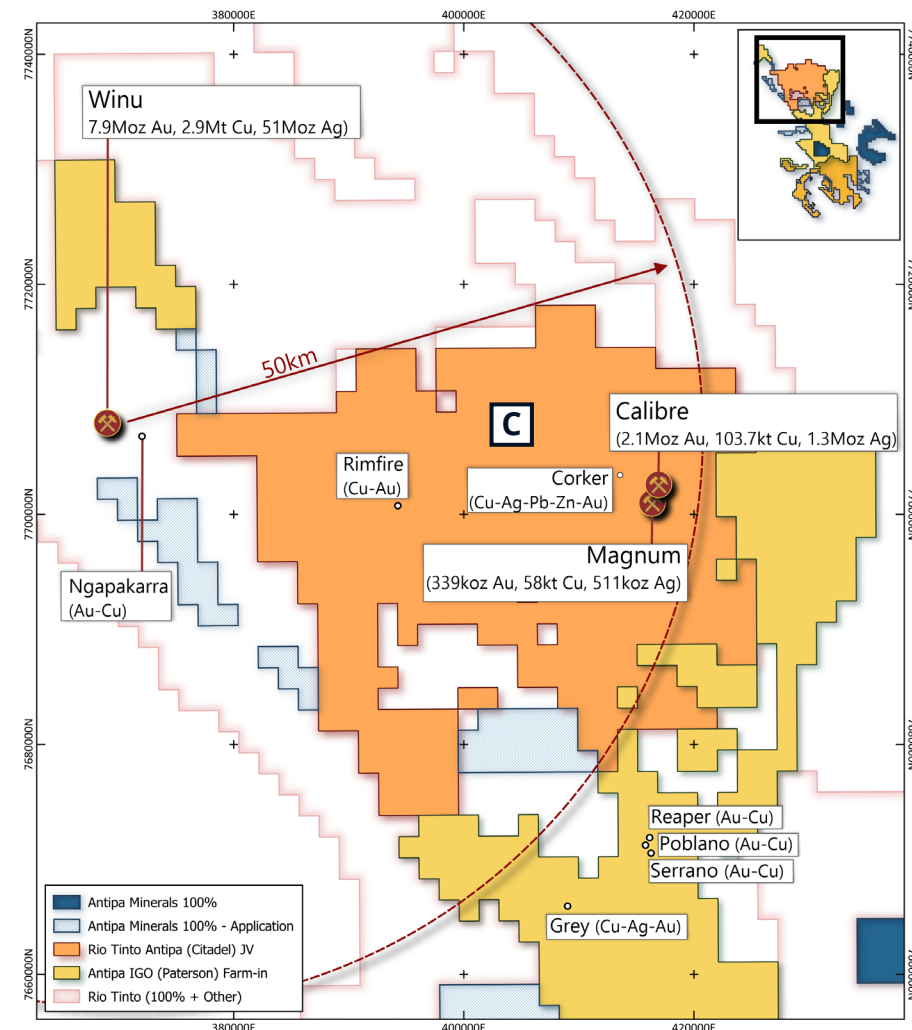

1. The gold equivalence calculation on this slide provides Antipa's Citadel Project attributable metal value for each metal summed and expressed in equivalent gold grade and ounces using metallurgical recoveries of 100% for all metals. The prices used in this calculation being LME close prices on 3 May 2022, Au US\$1,870/oz, Cu US\$9,510/t, Ag US\$ 23/oz and Co US\$81,220/t. Gold equivalent Moz = (((price Au per ounce x attributable ounces of Au) + (price Cu per tonne x attributable tonnes of Cu) + (price Ag per ounce x attributable ounces of Ag) + (price Co per tonne x attributable tonnes of Co))/ price Au per ounce)/1,000,000. Antipa confirms that it is not aware of any new information or data that materially affects the information included in relevant ASX releases, and that all material assumptions and technical parameters underpinning the Mineral Resource estimates in those releases continue to apply and have not materially changed.

2. Rio Tinto earned a 65% interest in the Joint Venture by sole funding A\$25M in exploration on the Citadel Project tenements. Antipa elected to utilise the dilute-down provisions in the Citadel JV Agreement to fund its share of the CY2022 and CY2023 exploration programmes, which will result in its JV interest being reduced from 35% to approximately 32%.

D

WILKI FARM-IN PROJECT (100% ANTIPA)

SUBSTANTIAL 1,470km² LAND HOLDING

ATTRACTIVE FARM-IN WITH NEWMONT¹

LOCATED WITHIN 3km OF THE TELFER GOLD-COPPER-SILVER MINE AND 22Mtpa PROCESSING FACILITY

AGREEMENT TO SPEND A\$60M FOR 75% JV INTEREST WITH A\$10M SPENT BY NEWCREST/NEWMONT TO DATE

2.4 MT MINERAL RESOURCE

Au 103.5 koz at 1.3 g/t

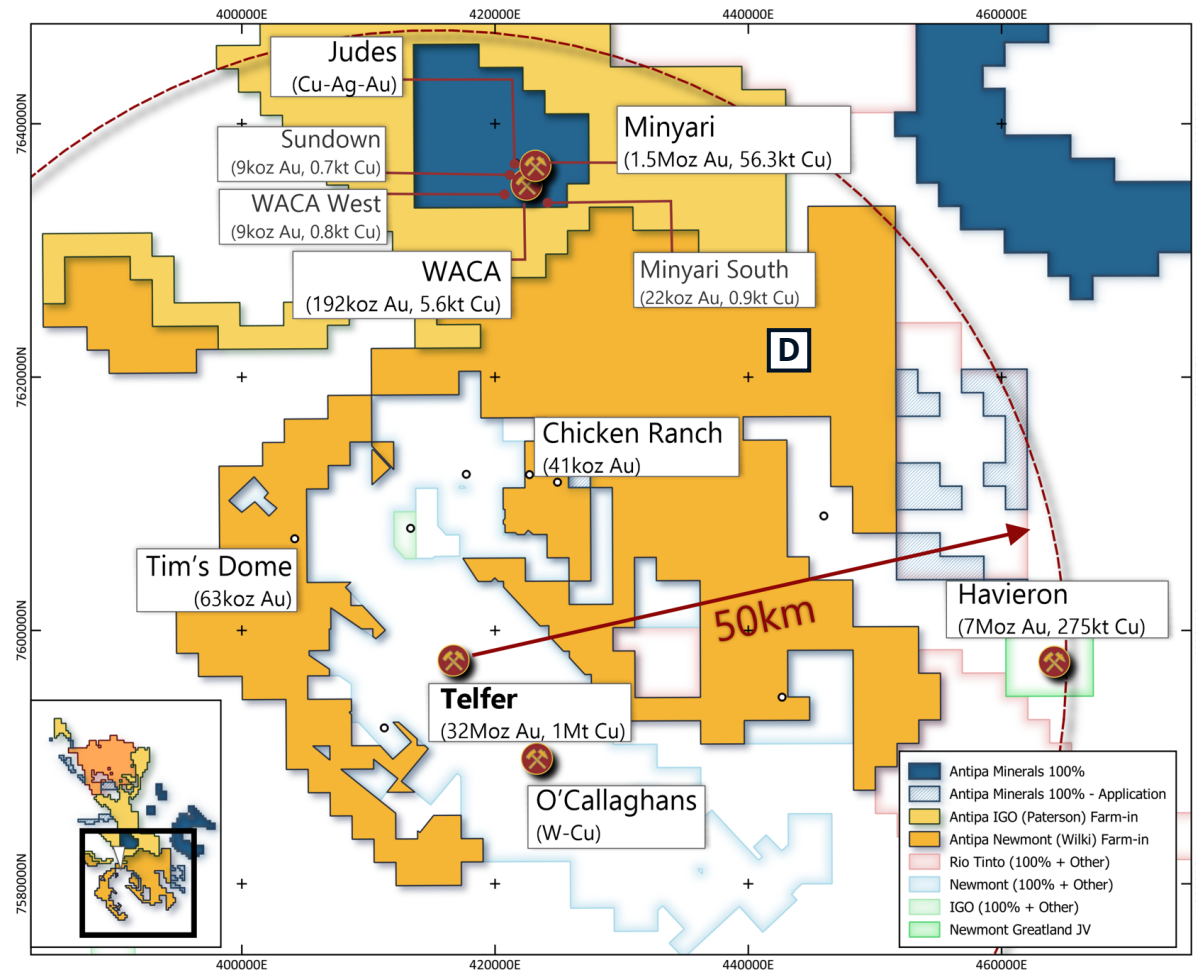

1. Newmont may earn a 51% interest in the Wilki Project tenements by funding A\$16M of exploration by March 2025 (consisting of A\$6M of exploration before March 2022 (Stage 1, which it has done) and a further A\$10M of exploration before March 2025 (Stage 2), the Stage 2 period may be extended by Newmont by two years to 28 February 2027.

JV AND FARM-IN PROJECT OVERVIEW

B PATERSON PROJECT: A\$30M IGO FARM-IN FOR UP TO 70% INTEREST (AZY 100%, IGO 0%)

- ~1,550km² Antipa / IGO Farm-in Project (agreed 9 July 2020) comes within 23km of Telfer and 8km of Rio's Winu copper-gold-silver development project
- Initial A\$4M minimum exploration programme within 2.5 years managed by Antipa completed ahead of schedule in December 2021
- IGO may earn a 70% interest in the Paterson Project by spending a further A\$26M within 6.5 years of commencement, to be managed at IGO's option (Total expenditure of A\$30M within 6.5 years of commencement of the Farm-in (by January 2027)
- Upon joint venture formation, IGO shall free-carry Antipa to completion of a Feasibility Study
- Managed and operated by IGO from March 2022
- IGO holds 3.6% interest in Antipa

C CITADEL JOINT VENTURE: ANTIPA 32%¹, RIO TINTO 68%¹ (RIO FUNDED A\$25M TO EARN 65%)

- ~1,200km² Citadel JV Project just 4km from Rio Tinto's Winu copper-gold-silver development project
- Existing Mineral Resource 2.4 Moz gold at 0.72 g/t, 162 kt copper at 0.15% and 1.8 Moz silver at 0.54 g/t
- Currently operated by Antipa
- Antipa utilising the dilute-down provision in JV agreement – Rio Tinto to sole fund CY2022 and CY2023 programmes¹

D WILKI PROJECT: A\$60M NEWMONT FARM-IN FOR UP TO 75% INTEREST (AZY 100%, NEM 0%)

- ~1,470km² Antipa / Newmont Farm-in Project (agreed 28 February 2020) comes to within 3km of Newmont's Telfer gold-copper-silver mine and 22Mtpa plant and 9km of Newmont-Greatland Gold's Havieron gold-copper development project
- Initial A\$6M minimum exploration programme within 2 years managed by Antipa (achieved December 2021)
- Newmont may earn a 51% interest in the Wilki Project by spending a further A\$10M within 5 years of commencement (28 February 2025), this period may be extended by Newmont by two years to 28 February 2027
- Newmont may earn up to 75% by sole funding a further A\$44M within 8 years of commencement (Total expenditure of A\$60M within 8 years of commencement of the Farm-in, i.e. by 28 February 2028)
- Managed and operated by Newcrest from July 2022 and Newmont from November 2023
- Newmont holds 8.6% interest in Antipa

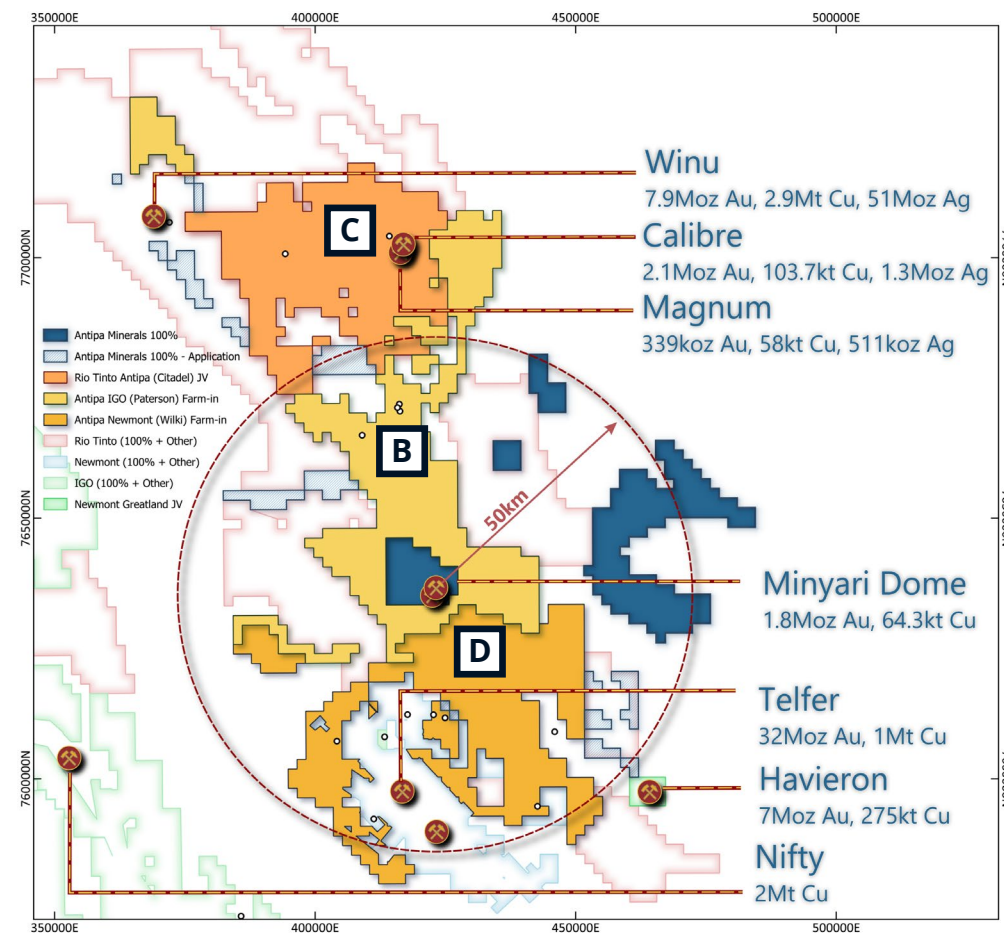

1. Antipa elected to utilise the dilute-down provisions in the Citadel JV agreement to fund its share of the CY2022 and CY2023 exploration programmes, which will result in its JV interest being reduced from 35% to approximately 32% and Rio's JV interest increasing from 65% to approx. 68%.



ANTIPAMINERALS



APPENDIX

MINERAL RESOURCE

Minyari Dome Project

Minyari Dome Project (Antipa 100%)¹

Deposit	Aueq cut-off	Category	Tonnes (Mt)	Au grade (g/t)	Cu grade (%)	Ag grade (g/t)	Co (%)	Au (oz)	Cu (t)	Ag (oz)	Co (t)
Minyari	0.5 Aueq	Indicated	15.00	1.17	0.19	0.54	0.04	567,000	27,800	259,600	5,930
Minyari	0.5 Aueq	Inferred	2.70	1.12	0.12	0.31	0.02	96,000	3,300	26,300	640
Minyari	1.5 Aueq	Indicated	4.40	2.30	0.26	0.83	0.03	328,000	11,400	118,400	1,450
Minyari	1.5 Aueq	Inferred	6.20	2.61	0.22	0.66	0.03	523,000	13,800	132,700	1,590
Total Minyari			28.30	1.66	0.20	0.59	0.03	1,514,000	56,300	537,000	9,610
WACA	0.5 Aueq	Indicated	1.69	0.97	0.11	0.17	0.02	52,000	1,900	9,400	310
WACA	0.5 Aueq	Inferred	1.54	1.02	0.12	0.18	0.02	51,000	1,800	9,100	300
WACA	1.5 Aueq	Inferred	1.63	1.69	0.11	0.17	0.03	89,000	1,900	9,000	560
Total WACA			4.86	1.23	0.11	0.18	0.02	192,000	5,600	27,500	1,170
Minyari South	0.5 Aueq	Inferred	0.15	4.51	0.56	1.04	0.05	22,000	900	5,100	80
Total Minyari South			0.15	4.51	0.56	1.04	0.05	22,000	900	5,100	80
Sundown	0.5 Aueq	Inferred	0.20	1.38	0.36	0.72	0.03	9,000	700	4,700	60
Total Sundown			0.20	1.38	0.36	0.72	0.03	9,000	700	4,700	60
WACA West	0.5 Aueq	Inferred	0.39	0.73	0.17	0.81	0.03	9,000	700	10,200	120
WACA West	1.5 Aueq	Inferred	0.01	0.86	0.50	0.05	0.01	304	55	17	1
Total WACA West			0.40	0.73	0.18	0.79	0.03	9,304	755	10,217	121
Total Minyari Dome Project			33.92	1.60	0.19	0.54	0.03	1,746,304	64,255	584,517	11,041

1. For full details of the 100% owned Minyari Dome Project Mineral Resources Estimate, please refer to ASX announcement dated 2 May 2022, "Minyari Dome Project Gold Resource Increases 250% to 1.8Moz".

MINERAL RESOURCE

Citadel JV Project and Wilki Farm-in Project

Citadel Project (Antipa 32%¹ and Rio Tinto 68%¹ JV)

Deposit	Aueq cut-off	Category	Tonnes (Mt)	Au equiv. (g/t) ²	Au grade (g/t)	Cu grade (%)	Ag grade (g/t)	Au equiv. (Moz) ²	Au (Moz)	Cu (t)	Ag (Moz)
Calibre	0.5 Aueq	Inferred	92	0.92	0.72	0.11	0.46	2.7	2.10	104,000	1.3
Magnum	0.5 Aueq	Inferred	16	-	0.70	0.37	1.00	-	0.34	58,000	0.5
Total Citadel Project (100% basis)			108	-	0.72	0.15	0.54	2.7	2.44	162,000	1.8

Wilki Project (Antipa 100%)

Deposit	Au cut-off	Category	Tonnes (Mt)	Au grade (g/t)	Cu grade (%)	Ag grade (g/t)	Co (ppm)	Au (oz)	Cu (t)	Ag (oz)	Co (t)
Chicken Ranch	0.5 Au	Inferred	0.8	1.6				40,300			
Tim's Dome	0.5 Au	Inferred	1.8	1.1				63,200			
Total Wilki Project			2.4	1.3				103,500			

Competent Persons Statement – Exploration Results

The information in this document that relates to Exploration Results is based on and fairly represents information and supporting documentation compiled by Mr Roger Mason, a Competent Person who is a Member of The Australasian Institute of Mining and Metallurgy. Mr Mason is a full-time employee of the Company. Mr Mason is the Managing Director of Antipa Minerals Limited, is a substantial shareholder of the Company and is an option holder of the Company. Mr Mason has sufficient experience relevant to the style of mineralisation and type of deposit under consideration and to the activity being undertaken to qualify as a Competent Person as defined in the 2012 Edition of the 'Australasian Code for Reporting of Exploration Results, Mineral Resources and Ore Reserves'. The Company confirms that the form and context in which the Competent Person's findings are presented have not been materially modified from the original market announcements, all of which are available to view on www.antipaminerals.com.au and www.asx.com.au. Mr Mason, whose details are set out above, was the Competent Person in respect of the Exploration Results in these original market announcements.

Competent Persons Statement – Mineral Resource Estimations for the Minyari Dome Project Deposits, Calibre Deposit, Magnum Deposit and Chicken Ranch Area Deposits and Tim's Dome Deposit

The information in this document that relates to the estimation and reporting of the Minyari Dome Project deposits Mineral Resources is extracted from the report entitled "Minyari Dome Project Gold Resource Increases 250% to 1.8 Moz" created on 2 May 2022 with Competent Persons Ian Glacken, Jane Levett, Susan Havlin and Victoria Lawns, the Tim's Dome and Chicken Ranch deposits Mineral Resources is extracted from the report entitled "Chicken Ranch and Tim's Dome Maiden Mineral Resources" created on 13 May 2019 with Competent Person Shaun Searle, the Calibre deposit Mineral Resource information is extracted from the report entitled "Calibre Gold Resource Increases 62% to 2.1 Million Ounces" created on 17 May 2021 with Competent Person Ian Glacken, and the Magnum deposit Mineral Resource information is extracted from the report entitled "Calibre and Magnum Deposit Mineral Resource JORC 2012 Updates" created on 23 February 2015 with Competent Person Patrick Adams, all of which are available to view on www.antipaminerals.com.au and www.asx.com.au. The Company confirms that it is not aware of any new information or data that materially affects the information included in the original market announcements and that all material assumptions and technical parameters underpinning the estimates in the relevant original market announcements continue to apply and have not materially changed. The Company confirms that the form and context in which the Competent Person's findings are presented have not been materially modified from the original market announcements.

Scoping Study Information:

The information in this document that relates directly to the 2022 Minyari Dome Project Scoping Study report was compiled by Mr. Roger Mason, a Competent Person who is a Member of The Australasian Institute of Mining and Metallurgy. Mr. Mason is employed as Managing Director of Antipa Minerals and has sufficient experience in the development of gold projects from the studies phase to the operational phase and consents to the inclusion in the report of the matters based on his information in the form and context in which it appears.

1. Antipa elected to utilise the Citadel JV agreement dilute-down provisions to fund its share of the CY2022 and CY2023 exploration programmes, which will result in its JV interest being reduced from 35% to approximately 32% and Rio's JV interest increasing from 65% to approximately 68%.
2. Refer to gold equivalent (Aueq or Au equiv.) calculation parameters on the following slide

MINERAL RESOURCE ESTIMATE

Gold Equivalent Calculations

Gold Metal Equivalent Information – Minyari Dome Project Mineral Resource Gold Equivalent reporting cut-off grade:

The 0.5 g/t and 1.5 g/t Aueq cut-off grades assume open pit and underground mining, respectively.

A gold equivalent grade (**Aueq**) has been calculated from individual gold, copper, silver and cobalt grades. This equivalent grade has been calculated and declared in accordance with Clause 50 of the JORC Code (2012), using the following parameters:

- The metal prices used for the calculation are as follows:
 - US\$ 1,944 per oz gold
 - US\$ 4.74 per lb copper
 - US\$ 25.19 per oz silver
 - US\$ 77,380 per tonne cobalt
- An exchange rate (A\$:US\$) of 0.7301 was assumed
- Metallurgical recoveries for by-product metals, based upon Antipa test-work in 2017 and 2018, are as follows:
 - Copper = 85.0%, Silver = 85%, Cobalt = 68%
- The gold equivalent formula, based upon the above commodity prices, exchange rate and recoveries, is thus:
 - **Aueq** = (Au g/t) + (Ag g/t * 0.011) + (Cu % * 1.42) + (Co % * 8.42)

Gold Metal Equivalent Information - Calibre Mineral Resource Gold Equivalent reporting cut-off grade and Gold Equivalent grade:

A gold equivalent grade (**Aueq**) has been calculated from individual gold, copper and silver grades. This equivalent grade has been calculated and declared in accordance with Paragraph 50 of the JORC Code, using the following parameters:

- The metal prices used for the calculation are as follows:
 - US\$ 1,874 /oz gold
 - US\$ 4.50 /lb copper
 - US\$ 25.25 /oz silver
- An exchange rate (A\$:US\$) of 0.722 was assumed.
- Metallurgical recoveries, based upon Antipa test-work in 2014, are as follows:
 - Gold = 84.5%, Copper = 90.0%, Silver = 85.4%
- A factor of 105% (as with the previous estimate) has been applied to the recoveries for gold, copper and silver to accommodate further optimisation of metallurgical performance. Antipa believes that this is appropriate, given the preliminary status of the recovery test-work.
- Tungsten has not been estimated and does not contribute to the equivalent formula.
- The gold equivalent formula, based upon the above commodity prices, exchange rate, recoveries, and using individual metal grades provided by the Citadel Project Mineral Resource Estimate table, is thus:
 - **Aueq** = Au (g/t) + (1.75*Cu%) + (0.014*Ag g/t)

Gold Metal Equivalent Information - Magnum Mineral Resource Gold Equivalent reporting cut-off grade:

A gold equivalent grade (**Aueq**) has been calculated from individual gold, copper, silver and tungsten grades. This equivalent grade has been calculated and declared in accordance with Paragraph 50 of the JORC Code, using the following parameters:

- The metal prices used for the calculation are as follows:
 - US\$ 1,227 /oz gold
 - US\$ 2.62 /lb copper
 - US\$ 16.97 /oz silver
 - US\$ 28,000 /t WO₃ concentrate
- An exchange rate (A\$:US\$) of 0.778 was assumed.
- Metallurgical recoveries, based upon Antipa test-work in 2014, are as follows:
 - Gold = 84.5%, Copper = 90.0%, Silver = 85.4% and W = 50.0%
- A factor of 105% (as with the previous estimate) has been applied to the recoveries for gold, copper and silver to accommodate further optimisation of metallurgical performance. Antipa believes that this is appropriate, given the preliminary status of the recovery test-work.
- Note that the tungsten recovery of 50% is considered indicative at this preliminary stage based on the initial metallurgical findings.
- Conversion of W% to WO₃% grade requires division of W% by 0.804.
- The gold equivalent formula, based upon the above commodity prices, exchange rate, and recoveries, is thus:
 - **Aueq** = (Au (g/t) x 0.845) + ((%Cu x (74.32/50.69) x 0.90)) + ((Ag (g/t) x (0.70/50.69) x 0.854)) + ((%W/0.804 x (359.80/50.69) x 0.50))

It is the Company's opinion that all the metals included in the metal equivalents calculations above have a reasonable potential to be recovered and sold.

A

T12

Phase 1 CY2024 drilling programme

- T12 is located 10km northwest of the Minyari deposit
- Very broad spaced CY2023 T12 air core drilling intersected gold mineralisation across a large area > 1km along strike by up to 400m across strike
- Multiple, shallow, 4m air core intersections were returned grading between 0.08 to 0.13 g/t gold ± copper-bismuth pathfinder anomalism
- Mineralisation present under very shallow cover ranging from between 1 and 3m
- Favourable address in an antiformal fold nose in interpreted Malu quartzites
- Interpreted thrust faulting providing potential mineral system fluid pathways

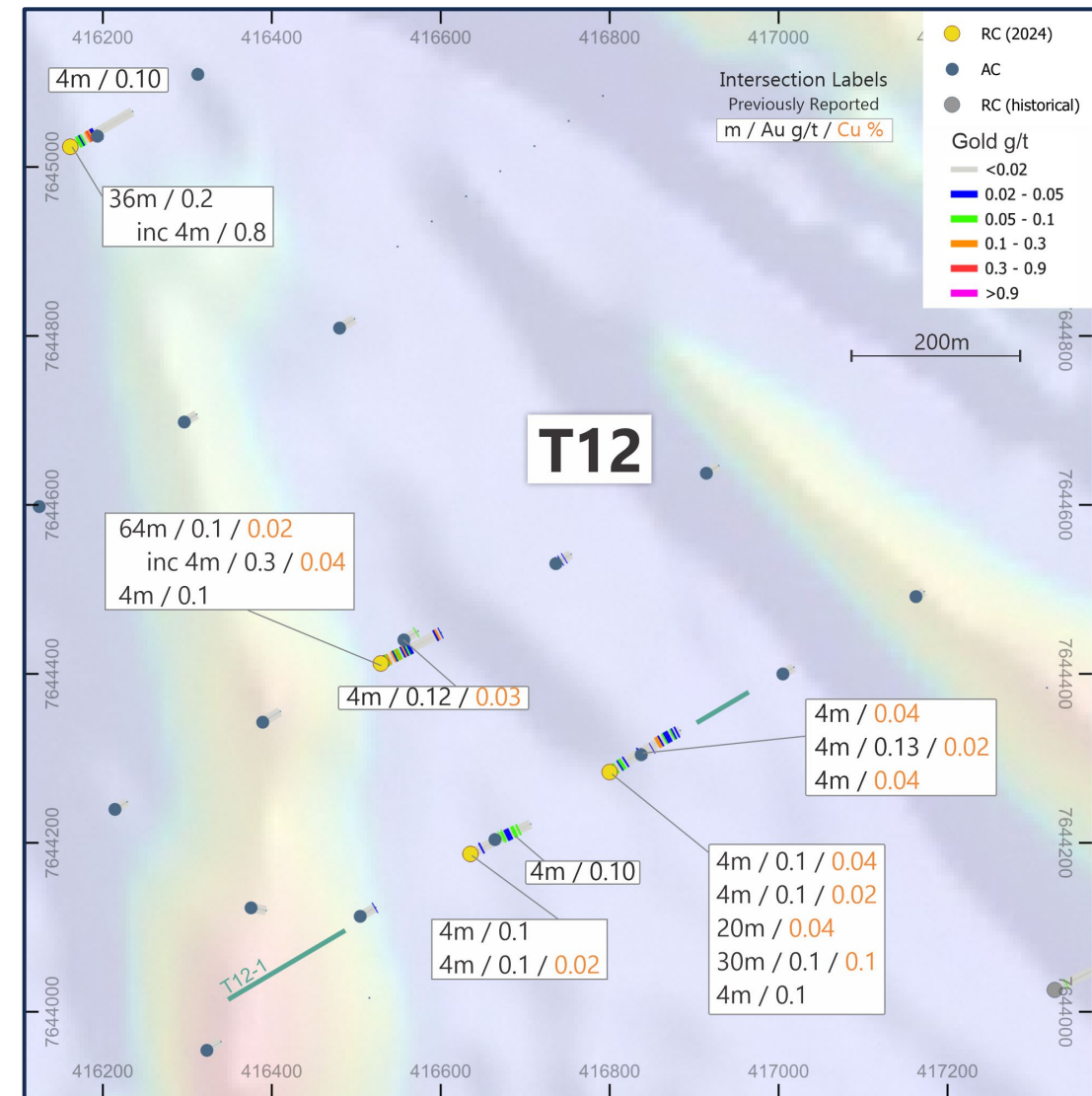

1. Exploration programmes and development studies are subject to changes which may be made consequent upon results, field conditions and ongoing review.

A

PACMAN TARGETS

High impact greenfield exploration

- Nifty copper deposit and Havieron analogue targets 30km east of Minyari:
 - **PM1** and **PM3** are both magnetic high \pm partially co-incident gravity high Havieron lookalikes
 - **PM2** is a gravity high and partially co-incident magnetic high Nifty analogue
- Hosted by interpreted Havieron equivalent stratigraphy under approximately 400m of cover 40 to 50km north along trend from Havieron
- Diamond core drilling completed (2,120m) at PM1 and PM2 – Results pending
- Diamond core drilling (up to 1,000m) at PM3 planned for H2 CY2024
- A\$440,000 WA Government co-funding drilling grants for Pacman

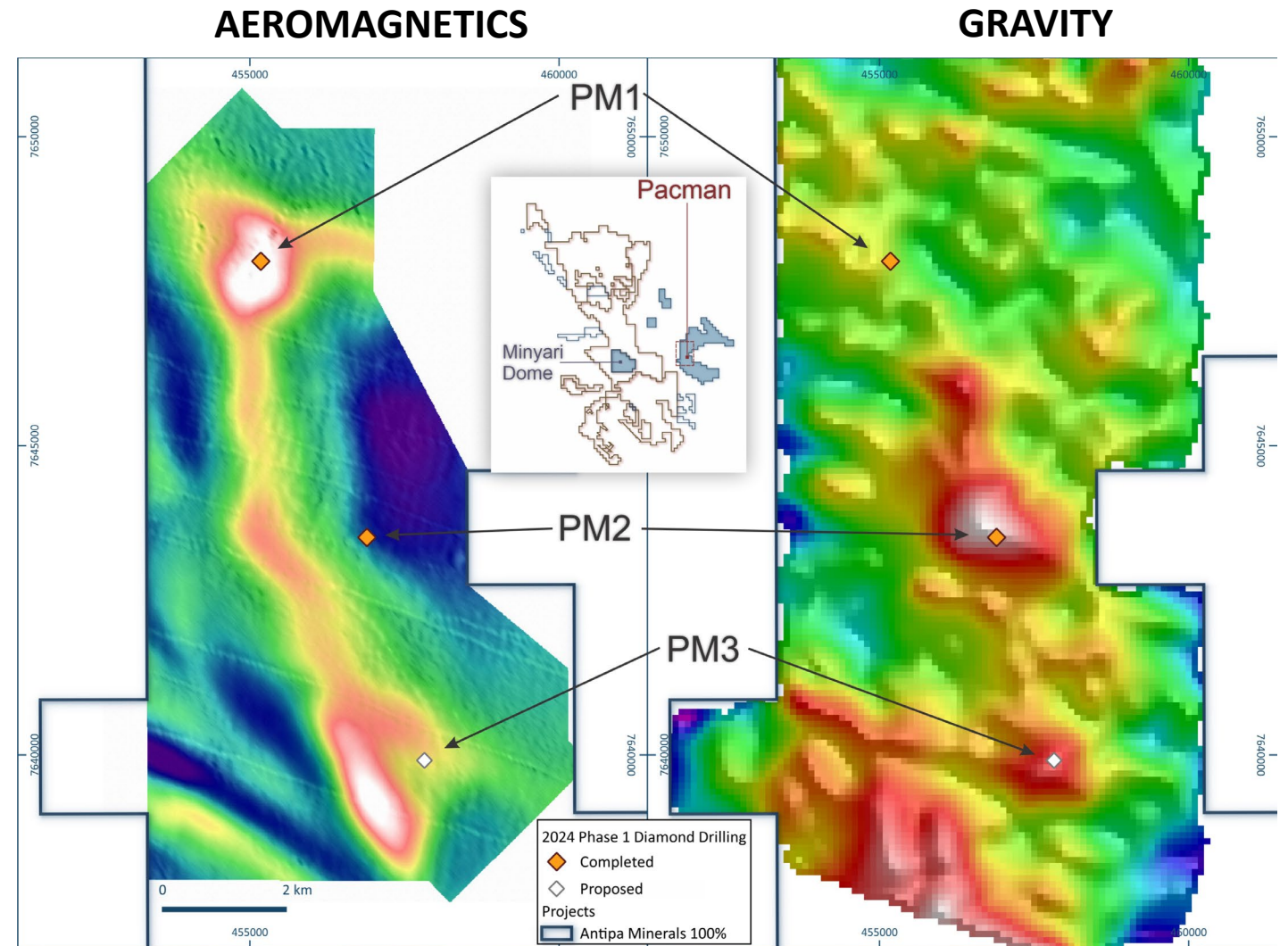

1. Exploration programmes and development studies are subject to changes which may be made consequent upon results, field conditions and ongoing review.

D NEW PARKLANDS TARGET

A very large-scale surface geochemical gold anomaly

- Located just 10km northeast of Newmont's Telfer gold-copper-silver 22Mtpa processing facility
- Coherent gold and mineral system pathfinder surface geochemical anomaly:
 - Very large 3km long by up to 1.5km wide
 - Peak surface geochemical lag result 1.52 g/t gold with multiple results > 0.1 g/t gold
 - Anomalous bismuth, tungsten, cobalt, sulphur, antimony, tin and selenium
- Favourable gold mineralisation anticlinal trap site, with fluid conduit plumbing including:
 - Situated on a northeast trending structure, which intersects Telfer; and
 - Thrust faulting concentrated in fold nose
- Shallow cover less than 20m
- Anomaly open to the southeast, northwest and north

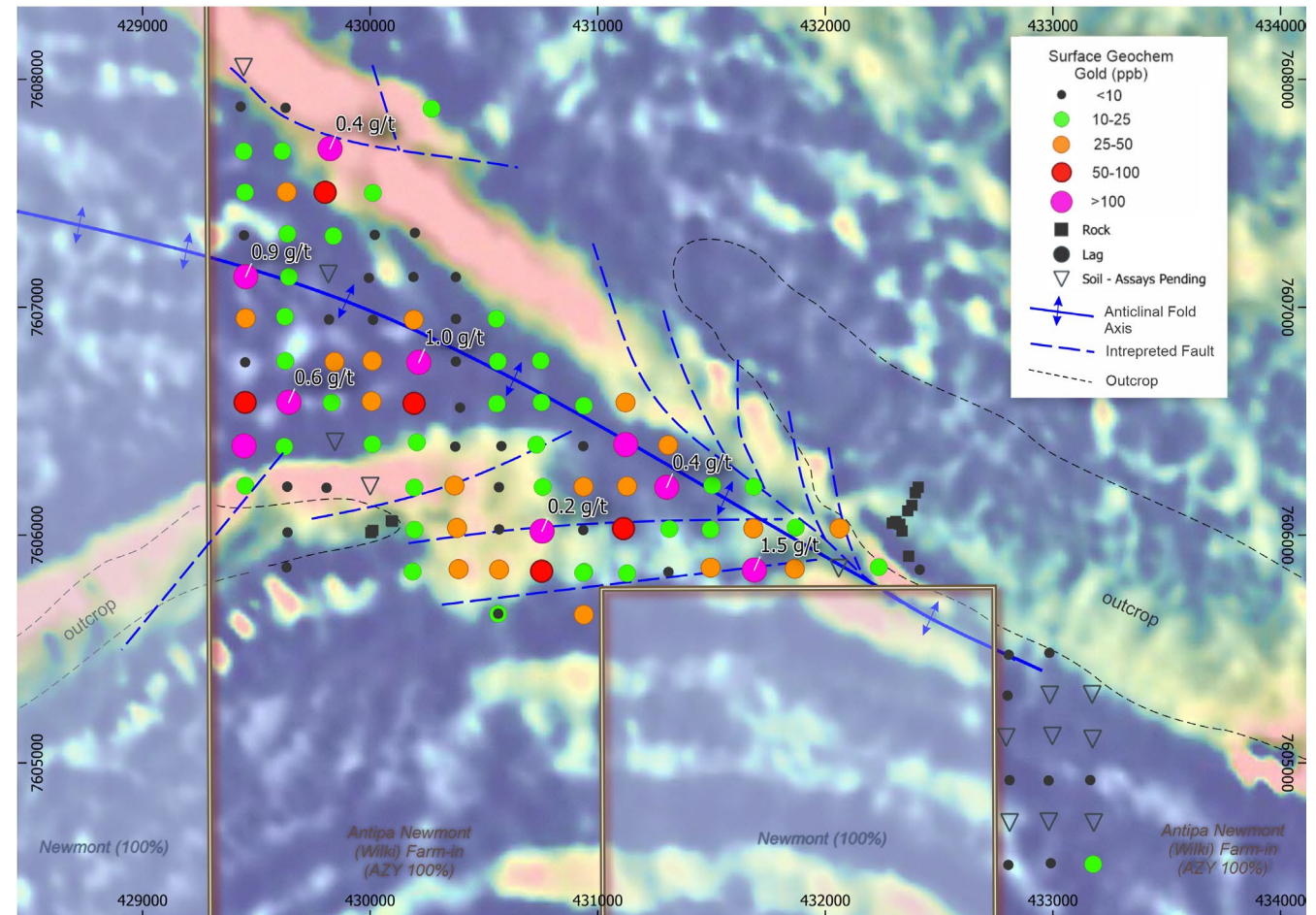

CONTACT DETAILS

MANAGING DIRECTOR

Mr Roger Mason
E: roger.mason@antipaminerals.com.au

EXECUTIVE DIRECTOR

Mr Mark Rodda
E: mark.rodde@antipaminerals.com.au

CORPORATE OFFICE

Level 2, 16 Ord Street
West Perth WA 6005
Australia

PO Box 795
West Perth WA 6872

T: +61 8 9481 1103
E: admin@antipaminerals.com.au

MEDIA RELATIONS

Mr Michael Vaughan
Fivemark Partners
E: michael.vaughan@fivemark.com.au
T: +61 422 602 720



ANTIPAMINERALS.COM.AU



ANTIPAMINERALS



THANK YOU